



FastMile 5G Gateway 3.2



User Guide
June 2023

Nokia is committed to diversity and inclusion. We are continuously reviewing our customer documentation and consulting with standards bodies to ensure that terminology is inclusive and aligned with the industry. Our future customer documentation will be updated accordingly.

This document includes Nokia proprietary and confidential information, which may not be distributed or disclosed to any third parties without the prior written consent of Nokia.

This document is intended for use by Nokia's customers ("You"/"Your") in connection with a product purchased or licensed from any company within Nokia Group of Companies. Use this document as agreed. You agree to notify Nokia of any errors you may find in this document; however, should you elect to use this document for any purpose(s) for which it is not intended, You understand and warrant that any determinations You may make or actions You may take will be based upon Your independent judgment and analysis of the content of this document.

Nokia reserves the right to make changes to this document without notice. At all times, the controlling version is the one available on Nokia's site.

No part of this document may be modified.

NO WARRANTY OF ANY KIND, EITHER EXPRESS OR IMPLIED, INCLUDING BUT NOT LIMITED TO ANY WARRANTY OF AVAILABILITY, ACCURACY, RELIABILITY, TITLE, NON-INFRINGEMENT, MERCHANTABILITY OR FITNESS FOR A PARTICULAR PURPOSE, IS MADE IN RELATION TO THE CONTENT OF THIS DOCUMENT. IN NO EVENT WILL NOKIA BE LIABLE FOR ANY DAMAGES, INCLUDING BUT NOT LIMITED TO SPECIAL, DIRECT, INDIRECT, INCIDENTAL OR CONSEQUENTIAL OR ANY LOSSES, SUCH AS BUT NOT LIMITED TO LOSS OF PROFIT, REVENUE, BUSINESS INTERRUPTION, BUSINESS OPPORTUNITY OR DATA THAT MAY ARISE FROM THE USE OF THIS DOCUMENT OR THE INFORMATION IN IT, EVEN IN THE CASE OF ERRORS IN OR OMISSIONS FROM THIS DOCUMENT OR ITS CONTENT.

Copyright and trademark: Nokia is a registered trademark of Nokia Corporation. Other product names mentioned in this document may be trademarks of their respective owners.

© 2022-2023 Nokia.

Table of contents

Safety guidelines	7
ISED notice	7
EMC notice	8
Introduction	11
Getting to know your FastMile 5G Gateway 3.2.....	12
About the modes	15
LTE only	15
5G NSA	15
5G SA	15
Physical interfaces	16
WiFi EasyMesh network with the FastMile 5G Gateway 3.2.....	17
Setting up the FastMile 5G Gateway 3.2	19
Checking the SIM status	19
Inserting the SIM card	20
Identifying the ideal location	21
Connecting the FastMile 5G Gateway 3.2.....	22
Starting the FastMile 5G Gateway 3.2	22
Managing the FastMile 5G Gateway 3.2 with the WiFi Mobile App	23
Connecting devices	25
Connecting WiFi devices to the FastMile 5G Gateway 3.2	25
Connecting Ethernet WAN/LAN	26
Connecting a device to the TEL port	27
What can you do with the WebUI	29
Configuring your network with the WebUI	31
Accessing the WebUI	31
WebUI screen hierarchy	35
Status hierarchy screens	35
Statistics hierarchy screens.....	36
Messages hierarchy screen	36
Network hierarchy screens	37
Application hierarchy screens	37
Security hierarchy screens	38
Diagnostics hierarchy screens	38
System hierarchy screens	38
WebUI screens	41
Overview screen.....	41
Network overview	41

Gateway information	42
Radio access	42
Devices	42
Status screen	43
Data usage	44
SIM	44
IMEI (International Mobile Equipment Identity)	45
Cellular WAN	45
LAN	45
Ethernet WAN	46
WiFi	46
Voice	47
Status 4G	47
Status 5G	48
Statistics screen	49
LAN statistics	49
Cellular statistics	50
WLAN statistics	51
Ethernet WAN statistics	52
Messages	53
Network screen	54
WiFi networks	54
2.4 GHz (network settings)	55
5 GHz (network settings)	57
WiFi schedule settings	60
Access Point Name parameters	60
Ethernet WAN	61
Static routes parameters	63
LAN settings	64
LAN	64
LAN IPv6	66
Connected devices	66
Application screen	67
Media server	67
Port forwarding	70
Port triggering	71
NTP	72
UPnP	73
Security screen	73
Firewall	74
IP filter	74
ALG and DMZ screen	75
Diagnostics screen	77
Logs	77
Speed test by Ookla	78
System screen	79
General	79
Unlocking or unblocking your SIM card	80
Changing the password	82

Device management	83
LED management	84
Logging out	87
Troubleshooting	89
Understanding the LED colors	89
Status LED	90
5G LED	91
Signal strength LED	92
Using the signal test button	92
Repositioning for a better signal	93
Using the power button	94
Using the reset button	95
Glossary	97
Technical specifications	99
Model 5G13-12W-A	99
Model 5G15-12W-A	100
Model 5G16-12W-A	101
4G / LTE radio frequency specifications	102
5G NR radio frequency specifications	105
Antenna gains	108
WiFi	110
5G NSA mode	110
5G SA	111
Warranty and safety	111
Manufacturer information	113
About Nokia	115

Safety guidelines

Follow these guidelines when using the FastMile 5G Gateway 3.2:



Danger: The FastMile 5G Gateway 3.2 must be installed and operated in compliance with the following radio frequency safety distance between the device and your body.

Table 1 FastMile 5G Gateway 3.2 RF exposure safety guidelines

Model	Kit part number	RF safety distance
5G13-12W-A	3TG-01889-AA	20 cm (7.8 in)
5G15-12W-A	3TG-01798-AA	30 cm (12 in)
	3TG-01798-AB	20 cm (7.8 in)
	3TG-01798-AC	20 cm (7.8 in)
	3TG-01798-AG	20 cm (7.8 in)
	3TG-01798-AH	20 cm (7.8 in)
	3TG-01798-AK	30 cm (12 in)
	3TG-01798-AM	20 cm (7.8 in)
5G16-12W-A	3TG-01799-AA	US: 29 cm (12 in), CAN: 35 cm (14 in)



Warning: If the gateway is dropped, especially on a hard surface, or in case of suspected damage, contact your service provider or where the device was purchased.



Warning: The FastMile 5G Gateway 3.2 must be used with power cables supplied with the equipment.

ISED notice

This device complies with the Canadian ICES-003 Class B specifications. CAN ICES-003(B)/ NMB-003 (B) IC: 21694-5G1612WA.

This device complies with Innovation, Science and Economic Development Canada license-exempt RSS standard(s). Operation is subject to the following two conditions:

- This device may not cause interference.
- This device must accept any interference, including interference that may cause undesired operation of the device.

Le présent appareil est conforme aux CNR Innovation, Sciences et Développement économique Canada applicables aux appareils radio exempts de licence. L'exploitation est autorisée aux deux conditions suivantes:

- L'appareil ne doit pas produire de brouillage.
- L'utilisateur de l'appareil doit accepter tout brouillage radioélectrique subi, même si le brouillage est susceptible d'en.

The device for operation in the band 5150-5250 MHz is only for indoor use to reduce the potential for harmful interference to co-channel mobile satellite systems.

EMC notice

The FastMile 5G Gateway 3.2 complies with part 15 of the FCC Rules. The Federal Communications Commission ID number for the FastMile 5G Gateway 3.2 is ADZR5G1612WA. Operation is subject to the following two conditions:

- This device may not cause harmful interference.
- This device must accept any interference received, including interference that may cause undesired operation.

This device has been tested and found to comply with the limits for a Class B digital device, pursuant to Part 15 of the FCC Rules. These limits are designed to provide reasonable protection against harmful interference in a residential installation. This equipment generates, uses and can radiate radio frequency energy and, if not installed and used in accordance with the instructions, may cause harmful interference to radio communications. However, there is no guarantee that interference will not occur in a particular installation. If this equipment does cause harmful interference to radio or television reception, which can be determined by turning the equipment off and on, the user is encouraged to try to correct the interference by one or more of the following measures:

- re-orient or relocate the receiving antenna
- increase the separation between the equipment and receiver

-
- connect the equipment into an outlet on a circuit different from that to which the receiver is connected
 - consult the dealer or an experienced radio/TV technician for help



Caution: Changes or modifications not expressly approved by the party responsible for compliance could void the user's authority to operate the equipment.

Introduction

Thank you for purchasing the FastMile 5G Gateway 3.2.

This document explains how to operate the FastMile 5G Gateway 3.2 at home using visual cues from the LED signals to achieve the best performance from the 4G/LTE or 5G network.

The contents of this guide are subject to change without notice.

Getting to know your FastMile 5G Gateway 3.2

You will find the following items in the box:

- (1) FastMile 5G Gateway 3.2
- (1) power adapter (mounts directly to the wall)
- (1) Quick Start Guide (QSG)
- (1) warranty card
- (1) safety card

Figure 1 FastMile 5G Gateway 3.2 unit views

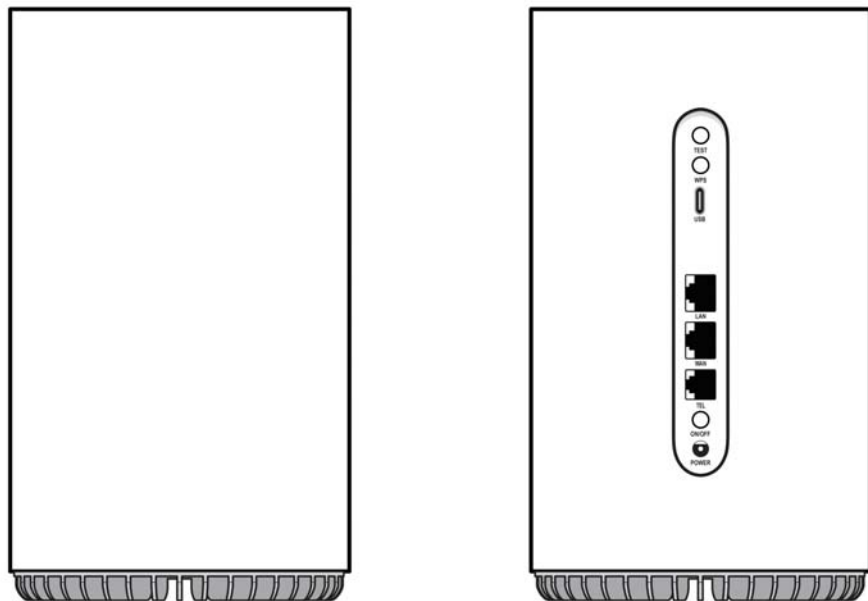

38713

The FastMile 5G Gateway 3.2 typically has 4G/LTE and/or 5G mobile network connectivity in the upstream (WAN) direction and the Nokia WiFi connectivity in the downstream (LAN) direction.

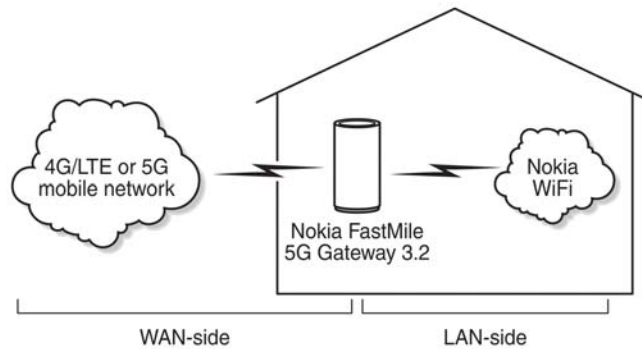
Figure 2 Network connections of the FastMile 5G Gateway 3.2

36815

The FastMile 5G Gateway 3.2 supports 5G NR and 4G LTE WAN connectivity. The device integrates chipsets compliant with 3GPP Rel-15 standards. Theoretical peak rates are DL 4.7 Gbps and UL 2.3 Gbps. Actual throughputs will vary based on aggregated bandwidths, network configuration, network load, and radio conditions.



Note: Projected peak throughput for NR TDD 2CA: 100 MHz + 100 MHz 256 QAM with 95% DL duty cycle.

Your device can operate either in 5G NR or in 4G LTE. Where both 4G and 5G are available, the FastMile 5G Gateway 3.2 supports dual connectivity EN-DC.

5G NR provides best download and upload speeds, thus improved user experience for data services such as Internet browsing and video streaming. In case 5G NR coverage is not available in your area, the device can also operate with 4G LTE only as your WAN connection.

FastMile 5G Gateway 3.2 provides the following features:

- 4G LTE and 5G NR WAN connection
- multi-band omni-directional antenna for 5G NR and 4G/LTE (maximum up to 7.6 dBi)
- self-contained integrated residential gateway with two Gigabit Ethernet LAN ports and support for WiFi connectivity
 - USB port type C
 - 2 RJ45 LAN ports
 - 12V DC power input jack
- optional features:

-
- one TEL port (RJ11) for voice service: supports VoLTE, VoNR, VoIP. The TEL port may be blocked and unavailable for certain providers
 - supports Bluetooth
 - supports GPS
 - supports 3-axis accelerometer
 - supports eSIM
 - hardware is modular to add two external antenna connectors (type TS-09) for 5G NR bands:
 - For model 5G15-12W-A: 3TG-01798-AB/AC/AG/AH/AM variants - n38/n40/n41/n78
 - For model 5G15-12W-A: 3TG-01798-AA - n40/n41/n78
 - For model 5G15-12W-A: 3TG-01798-AK - n78
 - For model 5G16-12W-A: n38/n41/n48/n77/n78
 - external antenna connectors are not included with the FastMile 5G Gateway 3.2.
 - supports Ethernet WAN (GE uplink connection)
 - supports WAN priority setting between Ethernet WAN and Wireless WAN
 - guest WiFi network support on 5G CPE standalone mode (non-mesh) enabled via WiFi Mobile App and ACS
 - acts as an access point of an WiFi EasyMesh network of WiFi Beacon 2 units (up to 3 Beacons supported)
 - Nokia WiFi connectivity:
 - WiFi 4 support
 - WiFi 5 support (IEEE 802.11ac)
 - WiFi 6 support (IEEE 802.11ax) - dual band 4+4 connectivity
 - 4x4 IEEE 802.11ax 2.4 GHz (40 MHz) WLAN interface, with MU-MIMO
 - 4x4 IEEE 802.11ax 5 GHz (80 MHz) WLAN interface, with MU-MIMO
 - Backward compatible with 802.11a/b/g/n/ac
 - WiFi security:
 - WPA/WPA2: AES encryption
 - WPA2 personal: AES encryption
 - WPA2/WPA3 transition mode
 - WPA3 personal: AES encryption
 - customized default WLAN key
 - WPS support

-
- PIN-locked SIM cards: a SIM PIN number is required to unblock the SIM card service
 - one logical temperature sensor
 - supports WebUI configuration to enable or disable single SSID: if enabled the CPE will merge 2.4 GHz band SSID and 5 GHz band SSID, and automatically select the frequency band that provides a faster speed
 - can operate in the following modes:
 - LTE-only
 - 5G NSA
 - 5G SA

About the modes

LTE only

When operating in the LTE-only mode, the FastMile 5G Gateway 3.2 will only use the 4G/LTE network to connect to the service provider's network.

5G NSA

When operating in the 5G NSA mode, the FastMile 5G Gateway 3.2 uses a 4G/LTE carrier and 5G NSA carrier at the same time to connect to the service provider's network.

5G SA

When operating in the 5G SA mode, the FastMile 5G Gateway 3.2 uses the 5G network to connect to the service provider's network.

Physical interfaces

The FastMile 5G Gateway 3.2 physical interfaces include those shown in the diagram, as well as the SIM card slot and reset button on the bottom of the device.

Figure 3 FastMile 5G Gateway 3.2 interface connections

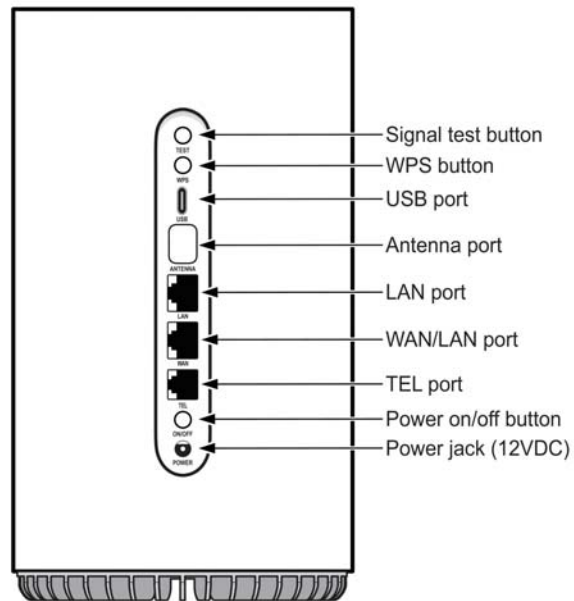

37257

Two RJ-45 LAN ports can be used for the following:

- to connect up to two Gigabit Ethernet LANs
- for management of the gateway through a locally connected PC or laptop



Note: The WAN port is configured by default as a LAN port.

Optional: One RJ-11 voice port to connect to the land line phone.



Note: The TEL port may be blocked and not available for certain providers.

The SIM card slot is for a 4FF/nano-size SIM card on the bottom of the device.

Figure 4 SIM card location

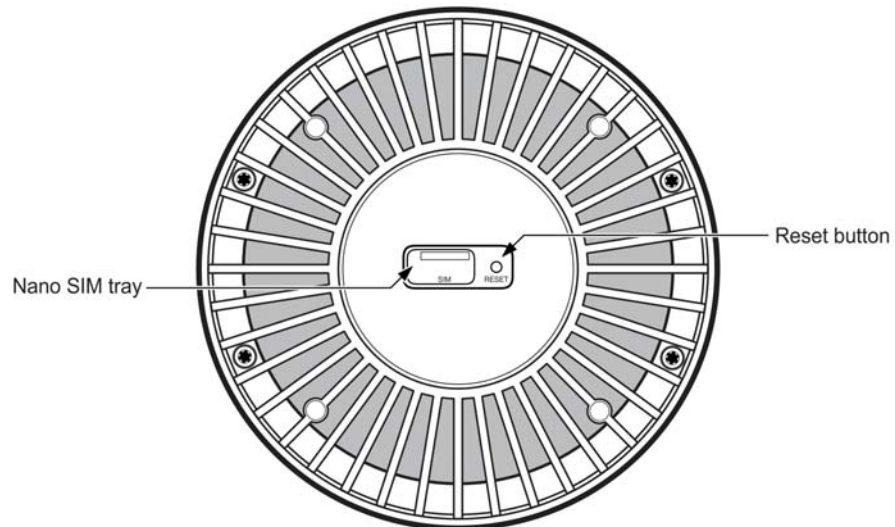

37277

WiFi EasyMesh network with the FastMile 5G Gateway 3.2

A WiFi EasyMesh network can be created by connecting a WiFi Beacon 2 to the FastMile 5G Gateway 3.2. The FastMile 5G Gateway 3.2 serves as the access point to the WAN while up to three WiFi Beacon 2 aid with extending WiFi coverage to every corner of the home, providing seamless roaming to wireless connections.

Both cloudless and cloud methods are supported; the cloud method is managed by NWCC.

Unlike typical WiFi networks that require unique SSIDs for each of the access points or tedious set-up of WiFi extenders, which complicate the user experience, a WiFi EasyMesh network of WiFi Beacon 2 simplifies the end user experience by providing easy device onboarding and automated network optimization.

Adding a WiFi Beacon 2 to create a mesh that has the FastMile 5G Gateway 3.2 as the access point can be done through the WiFi Mobile App. Contact your Nokia representative for more information about the WiFi Mobile App.

The WiFi Beacon 2 is not included as part of the FastMile 5G Gateway 3.2.

Setting up the FastMile 5G Gateway 3.2

Unpack the FastMile 5G Gateway 3.2, power adapter, and AC cable from the box.

Checking the SIM status

Before using the FastMile 5G Gateway 3.2, check the status of the SIM. Look on the sticker, located on the label on the bottom of the device for the part number (P/N). A generic sample of the bottom label below shows the location of the part number. Note that label content may differ per customer requirements.

Figure 5 Location of device part number

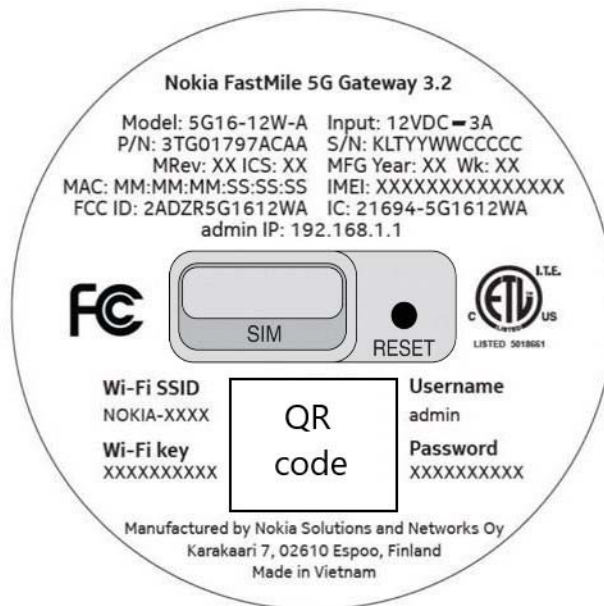

If the part number is 3TG-01797-ABXX, 3TG-01797-ACXX, or 3TG-01797-ADXX (the last two numbers can be any), the device is equipped with eSIM. Otherwise, the device is not equipped with eSIM and can operate only with the activated uSIM card.



Note: For eSIM use, a user profile must be installed on the device, which can only be done in the factory, based on the activation code provided by operator. Without the user profile, the eSIM is empty and can not be used.



Note: For the device equipped with eSIM, it supports both a primary and secondary SIM card (uSIM or eSIM). The uSIM is considered the primary SIM card; the eSIM is considered the secondary SIM card. If the uSIM card is inserted, the uSIM card will be used. If the uSIM card is removed, the eSIM card will be used.

The SIM card is normally provided by the network service provider or operator, and may be installed already. If the device is already installed with a SIM card (uSIM or eSIM), proceed to [Identifying the ideal location](#).

Inserting the SIM card



Note: The FastMile 5G Gateway 3.2 requires an appropriate 4FF/nano-size SIM card to connect to 4G/5G network. The gateway might also not start as expected without a SIM card.

For PIN-locked SIM cards, you will need to enter a PIN number. For PIN-blocked SIM cards, you will need to enter a PUK and a PIN number. See [Unlocking or unblocking your SIM card](#).

Turn the FastMile 5G Gateway 3.2 upside down.

Figure 6 Removing the SIM card tray

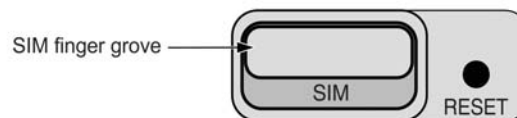

37273

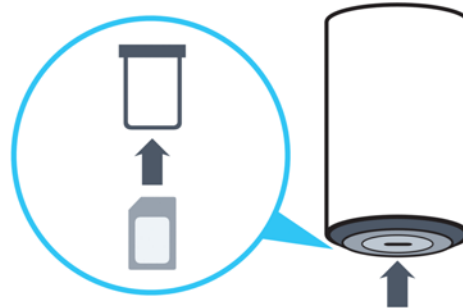
Figure 7 Inserting the SIM card

37274

Remove the SIM tray using the finger groove. Place the SIM card in the tray and insert it back into the gateway.

You can skip this step if the SIM card has already been installed by your service provider.

If the SIM card is missing, place the SIM card securely in the tray and insert it back into the FastMile 5G Gateway 3.2.

Identifying the ideal location

The ideal location for your FastMile 5G Gateway 3.2 will meet the following criteria:

- near a window where the 5G signal is strongest
- in an open space away from:
 - walls or obstructions
 - heavy-duty appliances or electronics such as microwave ovens and baby monitors
 - metal fixtures, enclosures, cabinets, reinforced concrete, or pipes
- near a power outlet
- on an upper floor of the home or at least 1.8m (6 ft) off the ground floor

Connecting the FastMile 5G Gateway 3.2

Place the FastMile 5G Gateway 3.2 on a flat surface, such as a tabletop or similar; close to a window, and near an electrical outlet.

Minimize the number of obstructions as much as possible.

The power adapter mounts directly into the electrical outlet in the wall.



Note: Ensure that no cables are blocking the air flow on the bottom of the FastMile 5G Gateway 3.2 to avoid overheating.

Starting the FastMile 5G Gateway 3.2

After the FastMile 5G Gateway 3.2 is connected to a power source, start the device by pressing the On/Off button located on the backside of the unit.

One or more LEDs on the top of the gateway will turn on soon.

There are 5 LEDs:

- status LED -in the middle of the circle
- 5G LED - above the status LED
- signal strength LEDs (3) - above the 5G LED

The FastMile 5G Gateway 3.2 starts searching for the best 5G connectivity. The status LED and the 5G LED start to blink and all signal LEDs are solid ON to indicate that the device is booting up.

When the signal strength LEDs go off, the booting-up phase is completed and the status LED is lit RED to indicate the signal search procedure.



Note: The signal search may take a few minutes.

Wait until the status LED is green. This indicates connectivity to 5G or 4G network.

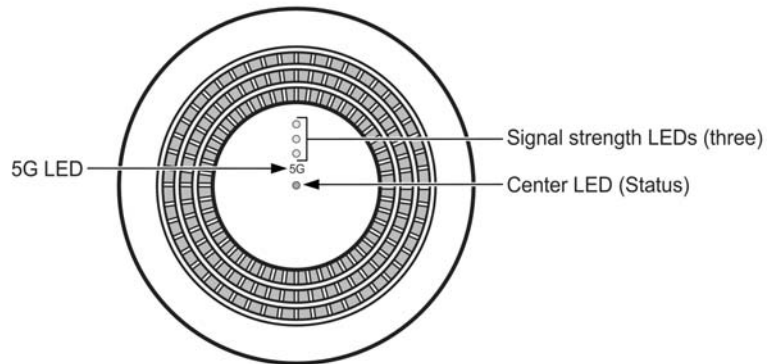
Figure 8 Location of status LEDs

37259

For more information about the LEDs, refer to the [Understanding the LED colors](#) section.



Note: You may need to repeat this cycle several times before finding the ideal location for the FastMile 5G Gateway 3.2.

Once you find a good signal, do not reposition the device. If the position changes, you may need to verify the signal strength again.

The LED on/off settings may prevent signal LEDs to be shown; this can be changed from the WebUI (LED management) or by using the signal test button.

Managing the FastMile 5G Gateway 3.2 with the WiFi Mobile App

To manage the gateway, use either the WebUI or the WiFi Mobile App. The WiFi Mobile App provides information that can help with installation, and provides guidance for tasks such as how to configure WiFi settings and how to add WiFi Beacon 2 devices to the WiFi network. The WiFi Mobile App can be downloaded from Google Play or the Apple App store.

Download the app to your phone or tablet to create an account.

Use the in-app QR code scanner to read the QR code that's located on the bottom of the FastMile 5G Gateway 3.2.

The FastMile 5G Gateway 3.2 pairs with your phone and performs initial configurations.

A generic sample of the bottom label below shows the location of the QR code. Note that label content may differ per customer requirements.

Figure 9 Location of the QR code

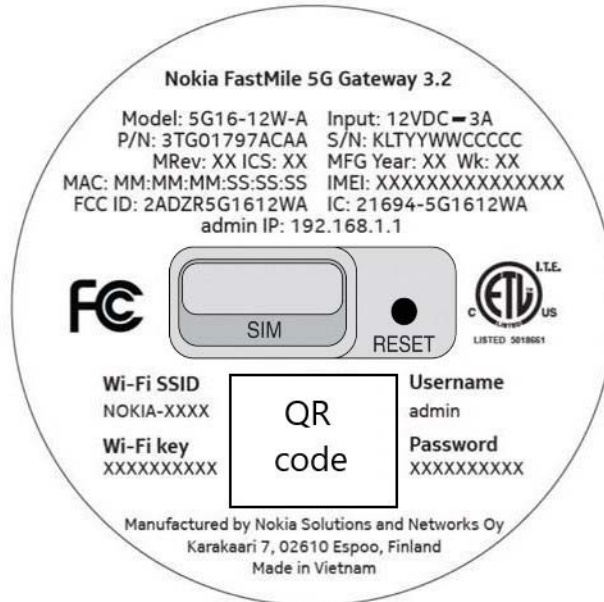

The WiFi Mobile App guides you through all the steps necessary to setup your FastMile 5G Gateway 3.2.

Contact your service provider for more information about the WiFi Mobile App.

Connecting devices

Connecting WiFi devices to the FastMile 5G Gateway 3.2

There are two ways to connect WiFi devices to the FastMile 5G Gateway 3.2: using SSID + WiFi key or press the WPS button on.

Connect WiFi devices to your FastMile 5G Gateway 3.2 by using the SSID and WiFi key information on the sticker on the bottom of your FastMile 5G Gateway 3.2.

Figure 10 Location of SSID and WiFi key

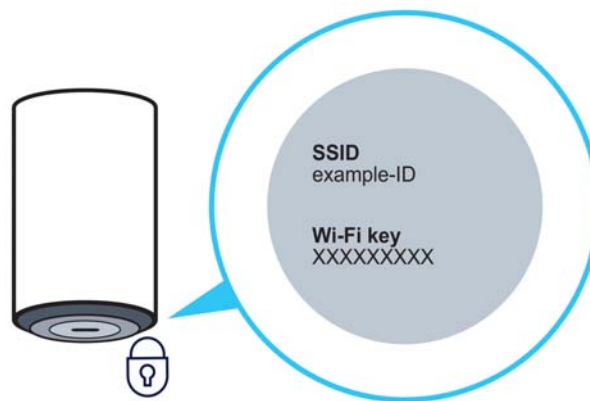

37275

The SSID format may differ per customer specific requirements.

Press the WPS button on the backside of the FastMile 5G Gateway 3.2 to start the WiFi Protected Setup process.



Note: Due to new WiFi password security rules that apply in R23.01, the user should change the default WiFi password to a new one that complies with the prompt instructions before being allowed to make any changes in the WiFi settings.

Connecting Ethernet WAN/LAN

You can connect up to two Gigabit Ethernet LANs by connecting the cable from the Ethernet LAN to either of the two Gigabit Ethernet LAN connectors on the backside of the FastMile 5G Gateway 3.2.

The second Ethernet WAN/LAN connector is configured as LAN by default but can be configured as Ethernet WAN by your service provider. If you have a fiber or cable broadband access (Ethernet WAN) you can use it instead of a mobile radio connection (wireless WAN). Contact your service provider who may offer either wireless or wired connectivity.

You can connect the Ethernet WAN by connecting the Ethernet cable from your fiber or cable router to the Ethernet WAN connector on the side of the FastMile 5G Gateway 3.2.



Note: When the Ethernet cable is connected to the Ethernet WAN connector port, the FastMile 5G Gateway 3.2 will try to use it as a primary connection.

Figure 11 Location of WAN/LAN ports on FastMile 5G Gateway 3.2

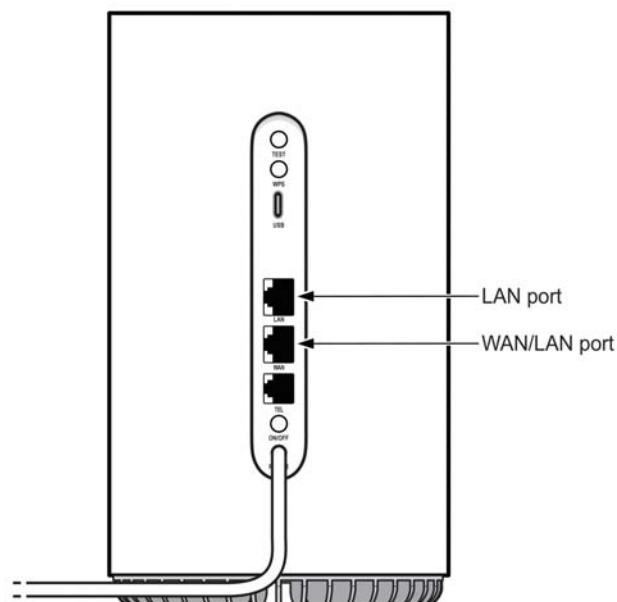

37260

Connecting a device to the TEL port

If your device supports an optional TEL port, you can connect a land line device that has a cable with an RJ11 connector to the TEL port on the backside of the FastMile 5G Gateway 3.2.

Figure 12 Location of the TEL port

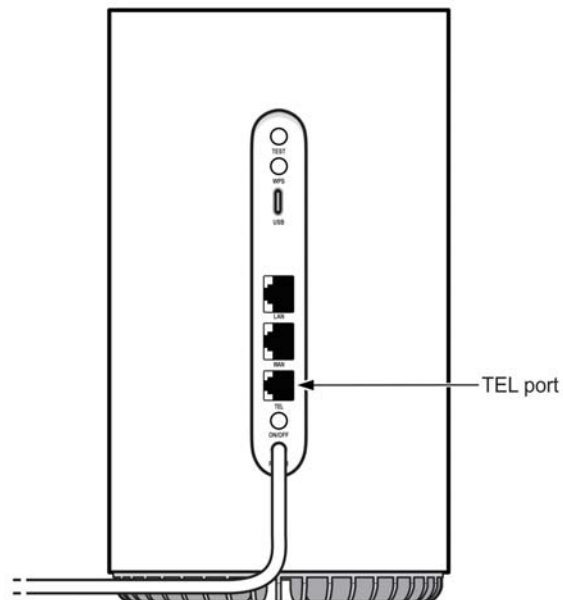

37261



Note: The TEL port is an optional feature and may be blocked or unavailable for certain providers.

What can you do with the WebUI

The FastMile 5G Gateway 3.2 supports a WebUI, which can be used for configuration, maintenance, and troubleshooting. You can collect device status through the WebUI for information on network connectivity.

You can configure the FastMile 5G Gateway 3.2 using the WebUI available on a PC or laptop. These devices must have an Ethernet LAN connection or a WiFi connection. The WebUI also displays useful information about the FastMile 5G Gateway 3.2. The FastMile 5G Gateway 3.2 is a secure device.

It is possible, via preconfiguration, that both http and https are enabled for access to the WebUI.

Configuring your network with the WebUI

You can manage the FastMile 5G Gateway 3.2 and any connected devices using the WebUI on a PC or laptop.



Note: The WebUI screens are designed for 1920 * 1080p resolution. The WebUI supported browsers include Chrome, Edge, Mozilla Firefox and Safari.

This section describes:

- how to establish a connection between the device on which you will access the WebUI and the FastMile 5G Gateway 3.2
- how to log into the WebUI when needed to view and configure network parameters

Accessing the WebUI

1. Ensure the Local Area Connection setting on your PC or laptop is configured as "obtain an IP address automatically".



Note: The FastMile 5G Gateway 3.2 must be powered up, see [Using the power button](#).

2. Do one of the following:
 - a. Establish a WiFi connection
 - b. Connect your PC or laptop through the RJ45 Gigabit Ethernet LAN ports on the backside of FastMile 5G Gateway 3.2
3. On your device, open a web browser, and enter the IP that is available on the label at the bottom of the gateway, for example:
<http://192.168.1.1> (default) or <https://192.168.1.1> (if pre-configured)

The Overview screen appears with the Nokia WebUI menu on the left of the screen.

Figure 13 WebUI main menu and the overview screen

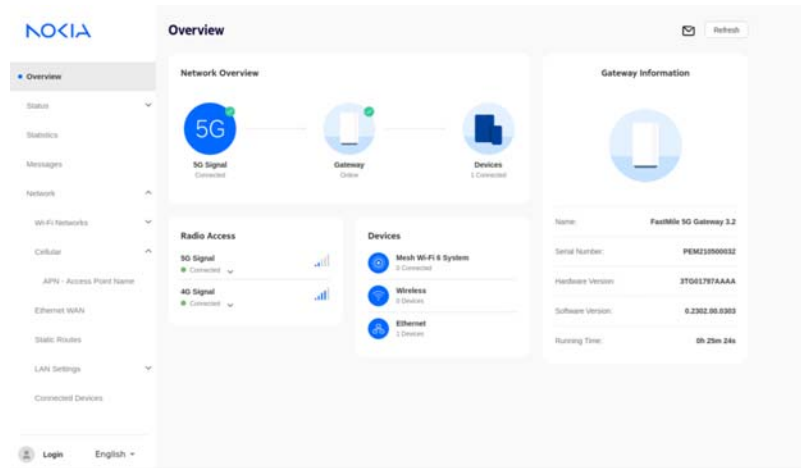

4. To log in, click Login or click on any of the menu items.
 The log in window appears and you are prompted to log in.
 Type the username and password in the respective fields and then click Login.



Note: After predefined consecutive unsuccessful login attempts, you will be locked out for a specific amount of time.

A generic sample of the bottom label below shows the location of the username and password. Note that label content may differ per customer requirements.

Figure 14 Location of username and password

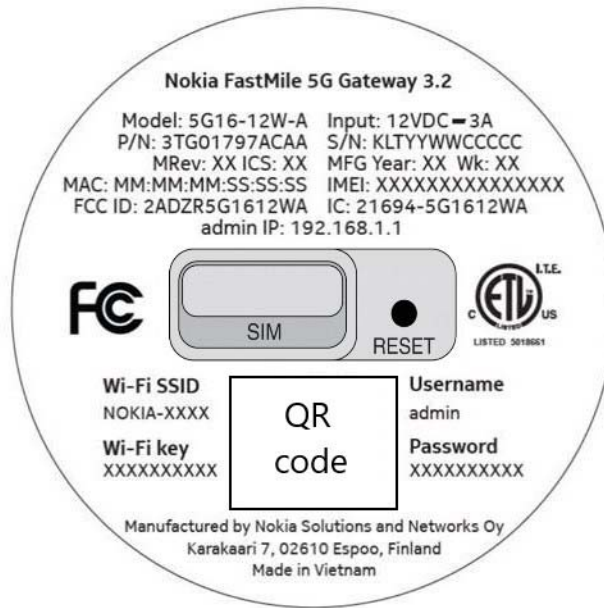

You should now see the overview screen which provides information about the FastMile 5G Gateway 3.2, radio access, and the connected devices.

To improve security, it is recommended that you change the default password. You can do this by going to the [Changing the password](#) procedure.

WebUI screen hierarchy

The following screen hierarchy illustrates the FastMile 5G Gateway 3.2 WebUI main menu to help you quickly navigate to the configuration task that you may need to complete.

Figure 15 Main menu



37262

Logging in allows you to select the following from the left-side menu options:

- status
- statistics
- messages
- network
- application
- security
- diagnostics
- system

Status, statistics, messages, network, application, security, diagnostics, and system menu options have sub-menus and screens, which are illustrated by the following figures.

Status hierarchy screens

The status screen provides the following menu options:

Figure 16 Status hierarchy screens

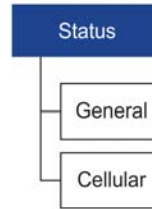

37263

Statistics hierarchy screens

The statistics screen provides information about the amount of data that has crossed the gateway for the following interface tab options:

Figure 17 Statistics hierarchy screens

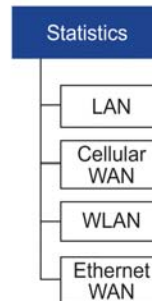

38202

Messages hierarchy screen

The messages screen will display all messages sent by the service provider.

Figure 18 Messages hierarchy screen



37265

Network hierarchy screens

The network screen provides the following menu options. Clicking on the arrow beside WiFi Networks, cellular, and LAN settings displays additional menu options.

Figure 19 Network hierarchy screen

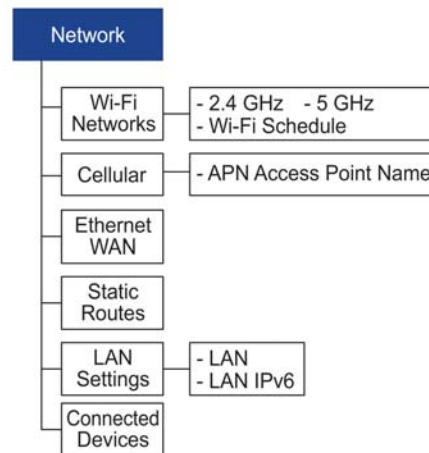

38203

Application hierarchy screens

The application screen provides the following menu options:

Figure 20 Application hierarchy screen

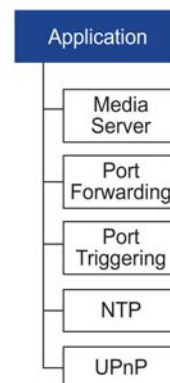

37267

Security hierarchy screens

The security screen provides the following menu options:

Figure 21 Security hierarchy screen

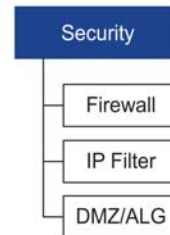

37268

Diagnostics hierarchy screens

The diagnostics screen provides the following menu options to view log files and perform speed tests by Ookla.

Figure 22 Diagnostics hierarchy screen

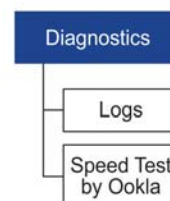

37269

System hierarchy screens

The system screen provides the following menu options:

Figure 23 System hierarchy screens

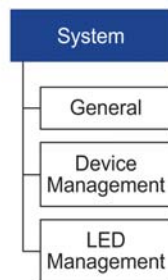

37270

WebUI screens

Overview screen

The overview screen contains four sections:

- network overview
- radio access
- devices
- gateway information
- unread messages, if any

Click Refresh at any time to update the displayed information.

Figure 24 Overview screen

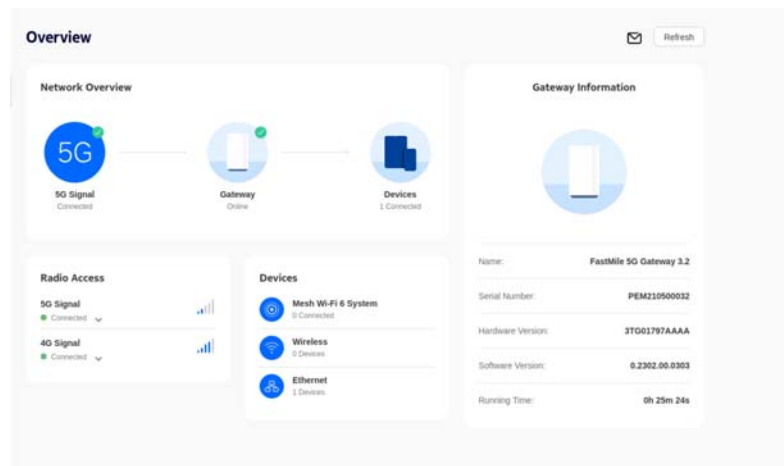

Network overview

The top of the overview screen shows the connection status of 5G, FastMile 5G Gateway 3.2, and the number of connected devices.

Gateway information

The gateway information section shows the following:

- name: the name and version of the gateway
- serial number
- hardware version
- software version
- running time: how long since the last FastMile 5G Gateway 3.2 reset/power cycle

Use this information when contacting the service provider for customer service.

Radio access

The 5G signal strength is represented by the number of bars, and the following parameters:

- RSRP
- SNR
- RSRQ

The 4G signal strength is represented by the number of bars and the following parameters:

- RSRP
- SNR
- RSRQ
- RSSI

Devices

Devices shows the number of devices connected to the FastMile 5G Gateway 3.2: Mesh WiFi 6 System, Wireless and Ethernet.

Status screen

From the WebUI left-side menu, selecting Status will show you information regarding:

Under the Status / General page, you can find the following:

- data usage
- SIM
- IMEI (International Mobile Equipment Identity)
- cellular WAN
- LAN
- Ethernet WAN
- WiFi
- voice (optional for supported model variants)

Under the Status / Cellular page, you can find the following:

- 4G: status, PCI, band, EARFCN, ECI, carrier aggregation, and total download/upload information
- 5G: status, PCI, supported bands, NR-ARFCN, NCI, carrier aggregation, and total download/upload information

Click Refresh at any time to update the displayed information.

The figures below show aspects of the status screen

Figure 25 Status / General page

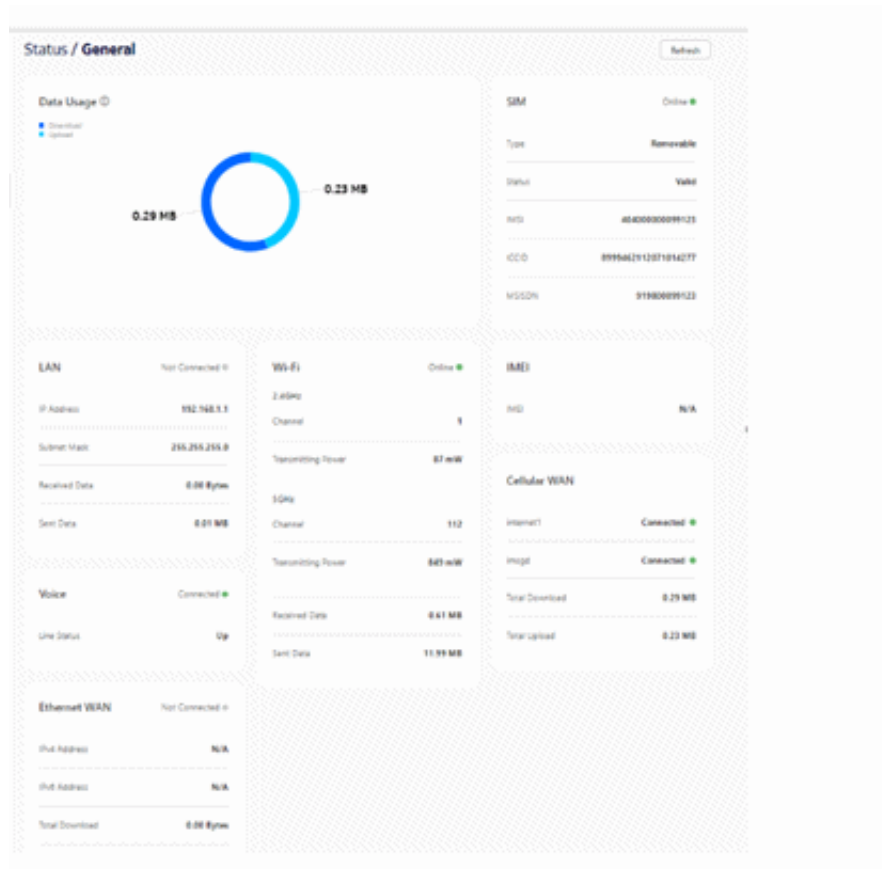

Data usage

Data usage represents the amount of data that is downloaded and uploaded from the FastMile 5G Gateway 3.2 since its latest reset/power-cycle.

SIM

The dot next to the SIM/eSIM is an indicator of the SIM status.

A green dot indicates your SIM is valid, activated and working well. In this case, next to the green dot you may also see your service provider name, if it is available. If the service provider name is not available but the dot is green, you will see “No Service”.

A gray dot indicates the SIM card is missing (see [Inserting the SIM card](#)), or may not be working, or it was installed incorrectly, or you will need to enter your PIN number (see [Unlocking or unblocking your SIM card](#)). In this case, next to the gray dot you will also see “No service”. Contact your service provider if you have checked that the SIM card is properly installed but the dot remains gray.



Note: For uSIM cards, when status shows *Available* it means PIN number verification is needed. When status shows *Blocked* it means the SIM PIN is locked and you need to input a PUK number and a new PIN number. When status shows *Error* it means the SIM card is destroyed because of a PUK error, or a modem failure, or a broken SIM card, or a specific PIN lock acceptance feature is not active but the SIM card PIN number is locked.

After another SIM card B with PIN enabled is inserted to the CPE and its PIN is verified, the SIM card A PIN number will be needed when it is inserted.

IMEI (International Mobile Equipment Identity)

IMEI information represents an identifier for each mobile device.

Cellular WAN

Under the Status / General page, there is the Cellular Network Card which has the following information:

- access point details include all APNs
- download and upload totals

For each APN, there is a dot to show connection status, as follows:

- green: connected
- gray: not connected

LAN

The LAN information status indicates whether a device is connected:

- green: there is a connection
- gray: there is no connection

You may view the following LAN connectivity information:

- IP address: local address
- subnet mask: default subnet mask
- received data: the amount of data received via the connection
- sent data: the amount of data sent via the connection

Ethernet WAN

The Ethernet WAN information status indicates whether a device is connected:

- green: there is a connection
- gray: there is no connection

You may view the following WAN connectivity information:

- IPv4 address: local address
- IPv6 address: local address
- total download: in bytes
- total upload: in bytes

WiFi

The WiFi status (online/offline) indicates whether the WiFi is active, regardless of whether a device is wirelessly connected:

- green: WiFi is enabled
- gray: WiFi is disabled

You may view WiFi connectivity information:

- 2.4 GHz information includes: the channel number and transmission power (mW)
- 5 GHz information includes: the channel number and transmission power (mW)
- received data: the amount of data received via the WiFi connection
- sent data: the amount of data sent via the WiFi connection

Voice

The voice feature is an optional feature that is enabled by your service provider and depends on the model variant of the FastMile 5G Gateway 3.2.

The voice status indicates whether a device is connected to the voice network and also indicates whether the POTS line is registered to it.

- green: there is a voice connection
- gray: there is no voice connection

You may view voice information about the line status:

- connected/not connected
- up/disabled
- registered/unregistered
- error

Status 4G

The Status / Cellular WAN page for the 4G status tab displays PCI, band, EARFCN, ECI, and carrier aggregation downlink / uplink status. In carrier aggregation, one or more carriers are combined to increase the capacity of the link, thereby increasing the bandwidth for the user.

Figure 26 Status / Cellular WAN Page / 4G





Note: When downlink or uplink carrier aggregation information is available, it will be displayed.

Status 5G

The Status/ Cellular WAN page for 5G status tab shows the detail information for status, PCI, supported bands, NR-ARFCN status, NCI, and carrier aggregation downlink / uplink status. In carrier aggregation, one or more carriers are combined to increase the capacity of the link, thereby increasing the bandwidth for the user.

Figure 27 Status / Cellular WAN Page / 5G

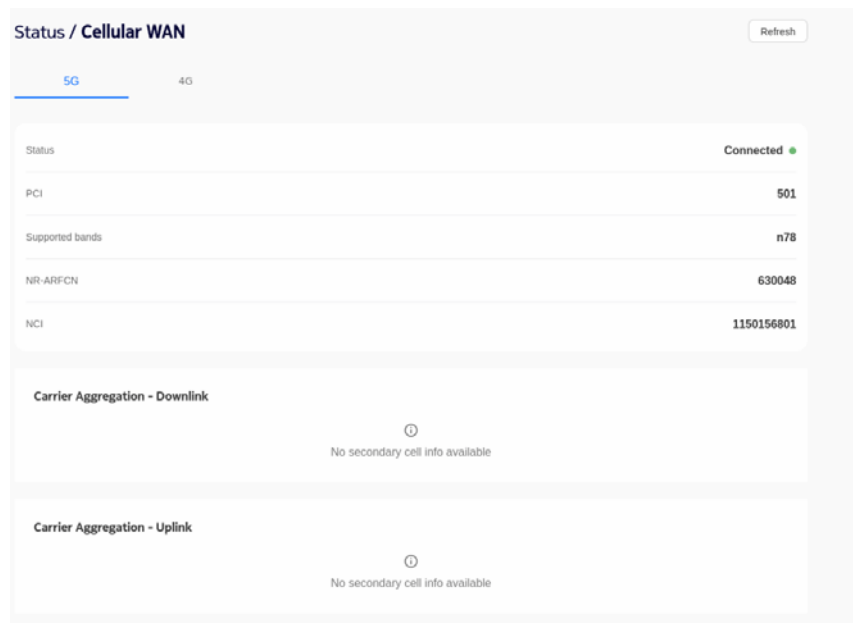

Note: When downlink or uplink carrier aggregation information is available, it will be displayed.

Statistics screen

From the WebUI left-side menu, selecting Statistics will show you the amount of data that has crossed the FastMile 5G Gateway 3.2 LAN, cellular WAN, WLAN and Ethernet WAN interfaces.

Click Refresh at any time to update the displayed information.

LAN statistics

By default, you will see the following statistics, per LAN port tab, upon accessing the statistics screen:

- status
- sent bytes
- received bytes
- sent packets
- received packets
- discarded sent packets
- discarded received packets
- sent errors
- received errors
- multicast sent packets
- multicast received packets

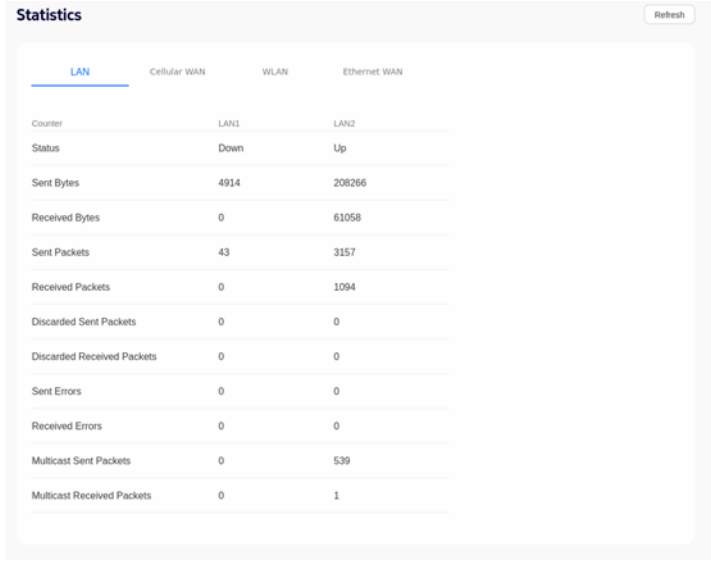
Figure 28 **Statistics: LAN**

The screenshot shows a web interface titled "Statistics" with a "Refresh" button in the top right corner. Below the title are four tabs: "LAN", "Cellular WAN", "WLAN", and "Ethernet WAN". The "LAN" tab is selected and underlined. The main content area displays a table with the following data:

Counter	LAN1	LAN2
Status	Down	Up
Sent Bytes	4914	208266
Received Bytes	0	61058
Sent Packets	43	3157
Received Packets	0	1094
Discarded Sent Packets	0	0
Discarded Received Packets	0	0
Sent Errors	0	0
Received Errors	0	0
Multicast Sent Packets	0	539
Multicast Received Packets	0	1

Cellular statistics

From the statistics screen, select Cellular WAN tab; you will see the following statistics (per configured Access Point Name and Service):

- sent bytes
- received bytes
- sent packets
- received packets
- sent errors
- received errors
- discarded sent packets
- discarded received packets

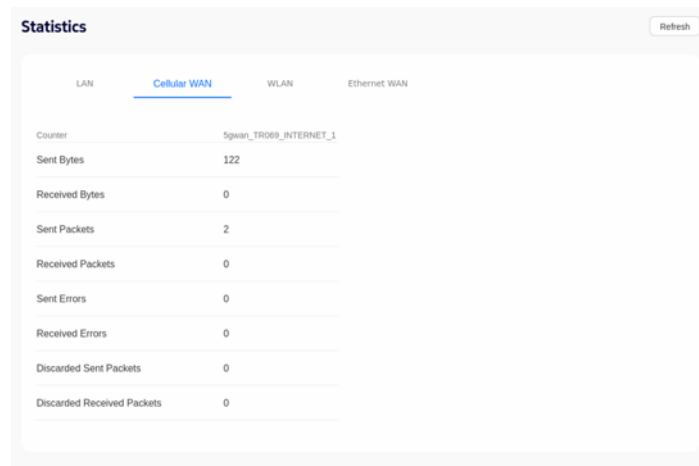
Figure 29 Statistics: Cellular WAN

LAN	Cellular WAN	WLAN	Ethernet WAN
Counter	5gwan_TR069_INTERNET_1		
Sent Bytes	122		
Received Bytes	0		
Sent Packets	2		
Received Packets	0		
Sent Errors	0		
Received Errors	0		
Discarded Sent Packets	0		
Discarded Received Packets	0		

WLAN statistics

From the statistics screen, select the WLAN tab; you will see the following statistics for 2.4 GHz and 5 GHz frequencies:

- SSID
- sent bytes
- received bytes
- sent packets
- received packets
- discarded sent packets
- discarded received packets
- sent errors

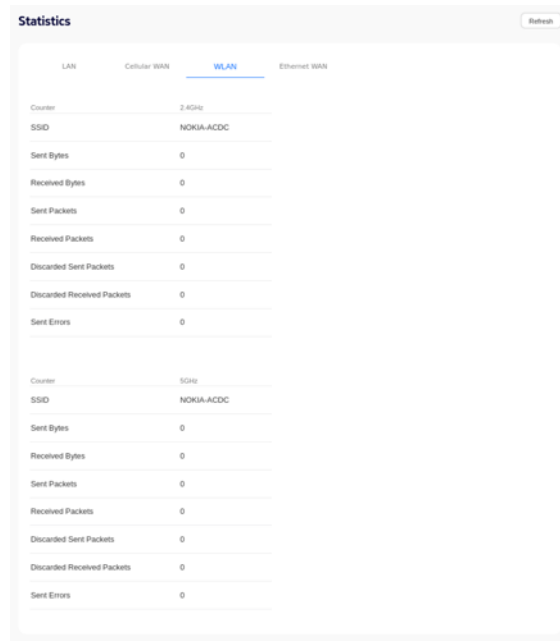
Figure 30 Statistics: WLAN

LAN	Cellular WAN	WLAN	Ethernet WAN
Counter 2.4GHz			
SSID NOKIA-ACDC			
Sent Bytes 0			
Received Bytes 0			
Sent Packets 0			
Received Packets 0			
Discarded Sent Packets 0			
Discarded Received Packets 0			
Sent Errors 0			
Counter 5GHz			
SSID NOKIA-ACDC			
Sent Bytes 0			
Received Bytes 0			
Sent Packets 0			
Received Packets 0			
Discarded Sent Packets 0			
Discarded Received Packets 0			
Sent Errors 0			

Ethernet WAN statistics

From the statistics screen, select the Ethernet WAN tab to see the following statistics information:

- sent bytes
- received bytes
- sent packets
- received packets
- sent errors
- received errors
- discarded sent packets
- discarded received packets

Figure 31 Statistics: Ethernet WAN

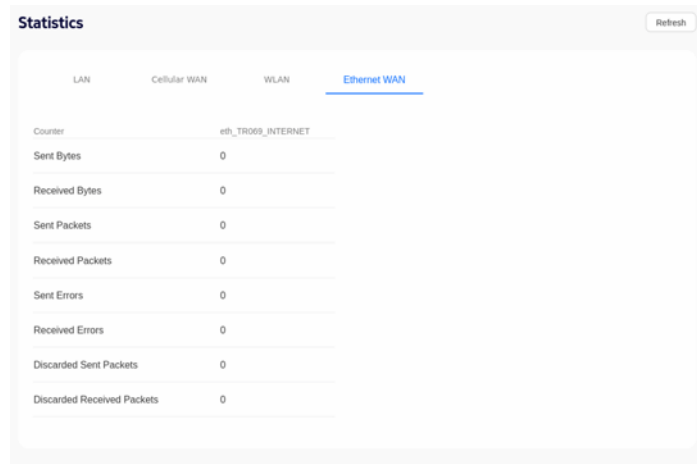

Messages

From the messages screen, you can see if you have any messages. Messages sent from the service provider can be viewed and deleted.

Figure 32 Messages

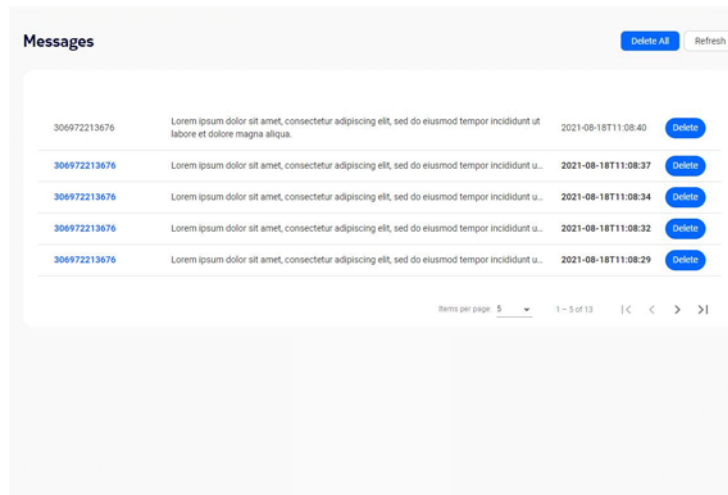

Network screen

From the WebUI left-side menu, select Network to manage the following:

- WiFi networks (2.4 GHz and 5 GHz networks) and WiFi schedule
- cellular (APN - Access Point Name)
- Ethernet WAN
- static routes
- LAN settings (LAN and LAN IPv6)
- connected devices



Note: When enabling guest mode WiFi via WiFi Mobile App, the first SSID which is not enabled on 2.4G/ 5G will be used for the guest SSID. Using ACS, you can select the SSID which is not enabled for the guest SSID.



Note: There is a WebUI configuration restriction in order for the unified WebUI configuration to align between the 5G CPE and WiFi Beacon 2.

For the 5G CPE WebUI guest WiFi configuration and restriction information, see the following sections that describe the network settings.

WiFi networks

From the network menu, select WiFi networks.

The 2.4 GHz, 5 GHz, and WiFi schedule menu options appear in the FastMile 5G Gateway 3.2 WebUI menu.



Note: Until unified WebUI configuration is available, the SSID1 and SSID5 should not be configured as guest mode, as this is not allowed in the WiFi Beacon 2 WebUI configuration.

When you configure the guest mode, the SSID should be configured with a pair. For example, it should operate with SSID2 and SSID6 together. When the SSIDs are configured as guest mode, this cannot be changed back to home mode directly, and a factory reset is needed to recover the SSID pair to the home configuration. This behavior is aligned with configuration on the Wireless Mobile App.

2.4 GHz (network settings)

Click 2.4 GHz.

The Network/WiFi Networks/2.4 GHz screen appears.

You can select the basic or the advanced screen view by clicking the appropriate radio button option at the top of the screen.

Figure 33 Network: WiFi Networks 2.4 GHz advanced view

The screenshot displays the 'Network / Wi-Fi Networks / 2.4GHz' configuration page in 'Advanced' mode. The settings are as follows:

- Settings Mode:** Basic (unselected), Advanced (selected)
- Wi-Fi 2.4GHz General Settings:**
 - Enable Wi-Fi 2.4GHz:
 - Transmission Mode: Auto (ax1g)
 - Channel Bandwidth: 20MHz
 - Channel: Auto
 - Transmission Power: 100%
- Enable Wi-Fi Multimedia (WMM):**
- Maximum Number Of Clients:** 120
- Configure SSID 1:**
 - Select SSID To Configure: SSID1
 - SSID Name: NOKIA-AD94
 - Enable Single SSID ID:
 - Enable SSID:
 - Guest Mode:
 - Enable Broadcast:
 - Total Number Of Clients: 120
 - Select Encryption Mode: WPA2/WPA3 (AES)
 - Wi-Fi Key: [masked]

A 'Save Changes' button is located at the bottom of the form.

The advanced view includes the following parameters to configure:

- WiFi 2.4 GHz general settings:
 - enable WiFi 2.4 GHz
 - transmission mode
 - channel bandwidth
 - channel

- transmission power
- enable WiFi Multimedia (WMM)
- maximum number of clients
- configure SSID 1:
 - select SSID to configure
 - SSID name
 - enable single SSID
 - enable SSID
 - enable broadcast
 - total number of clients
 - select encryption mode
 - WiFi key
- configure guest mode, if desired using a valid SSID pair

Figure 34 Network: WiFi Networks 2.4 GHz basic view

The screenshot displays the 'Network / Wi-Fi Networks / 2.4GHz' configuration page. At the top, there are two tabs: 'Basic' (selected) and 'Advanced'. Below this, the 'Wi-Fi 2.4GHz General Settings' section contains a toggle for 'Enable Wi-Fi 2.4GHz' which is turned on. The 'Configure SSID 1' section includes a text input for 'SSID Name' containing 'NOKIA-ADB4', a toggle for 'Enable Single SSID' which is turned off, and a text input for 'Wi-Fi Key' with a visibility icon. A blue 'Save Changes' button is located at the bottom of the form.

The basic view includes the following parameters to configure:

- WiFi 2.4 GHz general settings:
 - enable WiFi 2.4 GHz
- configure SSID 1:
 - SSID name

-
- enable single SSID
 - WiFi key

Click Save Changes.

5 GHz (network settings)

From the network menu, select WiFi networks.

The 2.4 GHz, 5 GHz, and WiFi schedule menu options appear in the FastMile 5G Gateway 3.2 WebUI menu.

Click 5 GHz.

The Network/WiFi Networks/5 GHz screen appears.

You can select the basic or the advanced screen view by clicking the appropriate radio button option at the top of the screen.

Figure 35 Network: WiFi Networks 5 GHz advanced view

The screenshot displays the 'Network / Wi-Fi Networks / 5GHz' configuration page. It features two tabs: 'Basic' and 'Advanced', with 'Advanced' selected. The page is divided into two main sections: 'Wi-Fi 5GHz General Settings' and 'Configure SSID 5'.

Wi-Fi 5GHz General Settings:

- Enable Wi-Fi 5GHz:
- Transmission Mode: Auto (ax1a)
- Channel Bandwidth: 80MHz
- Channel: Auto
- Transmission Power: 100%
- Enable Wi-Fi Multimedia (WMM):
- Enable MU-MIMO:
- Maximum Number Of Clients: 128

Configure SSID 5:

- Select SSID To Configure: SSID5
- SSID Name: NOKIA-ADB4
- Enable Single SSID:
- Enable SSID:
- Guest Mode:
- Enable Broadcast:
- Total Number Of Clients: 128
- Select Encryption Mode: WPA2/WPA3 (AES)
- Wi-Fi Key: [masked]

A 'Save Changes' button is located at the bottom of the form.

The advanced view includes the following parameters to configure:

- WiFi 5 GHz general settings:
 - enable WiFi 5 GHz
 - transmission mode
 - channel bandwidth
 - channel
 - transmission power
 - enable WiFi Multimedia (WMM)
 - enable MU-MIMO
 - maximum number of clients
- configure SSID 5:
 - select SSID to configure
 - SSID name

- enable single SSID
 - enable SSID
 - enable broadcast
 - total number of clients
 - select encryption mode
 - WiFi key
- configure guest mode, if desired using a valid SSID pair

Figure 36 Network: WiFi Networks 5 GHz basic view

The screenshot shows the 'Network / Wi-Fi Networks / 5GHz' configuration page in a web interface. At the top, there are two tabs: 'Basic' (selected) and 'Advanced'. Below the tabs, the page is titled 'Settings Mode'. Under 'Wi-Fi 5GHz General Settings', there is a toggle for 'Enable Wi-Fi 5GHz' which is turned on. Below that is a section for 'Configure SSID 5' with a text input field for 'SSID Name' containing 'NOKIA-ADB4'. There is also a toggle for 'Enable Single SSID' which is turned off. At the bottom of this section is a 'Wi-Fi Key' field with a password icon and a masked key. A blue 'Save Changes' button is located at the bottom center of the configuration area.

The basic view includes the following parameters to configure:

- WiFi 5 GHz general settings:
 - enable WiFi 5 GHz
- configure SSID 5:
 - SSID name
 - enable single SSID
 - WiFi key

Click Save Changes.

WiFi schedule settings

From the network menu, select WiFi networks.

The 2.4 GHz, 5 GHz, and WiFi schedule menu options appear in the FastMile 5G Gateway 3.2 WebUI menu.

Click WiFi Schedule.

The WiFi Networks/WiFi Schedule screen appears.

Figure 37 WiFi Networks / WiFi Schedule

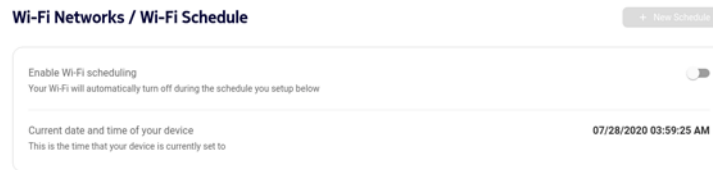

1. Enable the WiFi Scheduling to turn the wireless signal off for the configured period.
2. Click the + New Schedule button to add a rule.
A panel appears for configuring wireless schedule rules.
3. Enter a start and end time for the period for which you want the wireless signal to be off.
4. Choose Everyday or a Specific day(s) of the week.
If you choose specific day(s), select the check boxes for the desired days.
The Recurrence Pattern shows the rules created to date.
5. Click Add.
6. View the current date and time of your device.

Access Point Name parameters

From the network / cellular menu, select APN Access Point Name.

The Network / Cellular / APN - Access Point Name screen appears.

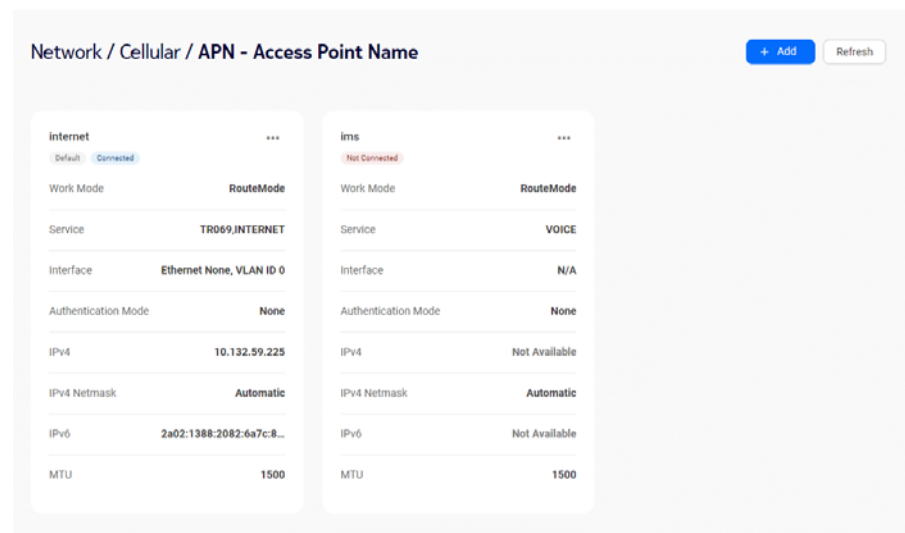
Figure 38 Network/Cellular: Access Point Name

Edit and delete access points by clicking the options icon (three dots in the top right corner of each access point box). You can configure up to 8 access points using route mode and bridge mode. Voice service is available for supported model variants.

Contact your service provider for more information about access points.

Click Update.

Ethernet WAN

From the network menu, select Ethernet WAN.

The Network/Ethernet WAN screen appears.

Figure 39 Network: Ethernet WAN

Network / Ethernet WAN Refresh

WAN Access Mode Cellular

[Save Changes](#)

eth_TR069_INTERNET ...	
Supported service(s)	TR069,INTERNET
Connection type	IPoE
PPPoE Username	N/A
IPv4 Address	N/A
IPv6 Address	N/A
VLAN	Disabled

You can configure the following WAN access modes:

- cellular
- cellular preferred
- Ethernet preferred

Click Save Changes.

You can configure the following Ethernet WAN settings:

- supported service(s)
- connection name
- connection type: IPoE or PPPoE
- IPoE IP mode: IPv4 or IPv6, or IPv4 and IPv6
- PPPoE IP mode: IPv4 or IPv6, or IPv4 and IPv6
- PPPoE user name
- PPPoE password
- IPoE IPv6 or IPv4 plus IPv6 address method and prefix delegation
- VLAN

Figure 40 Network: Configure Ethernet WAN Connection edit screen sample

Click Update.

Static routes parameters

From the network menu, select Static Routes.

The Network/Static Routes screen appears.

Figure 41 Network: Static Routes

After configuring the applicable parameters:

- destination IPv4
- destination netmask
- gateway IPv4
- interface

You can add a static route by clicking Add+.

You can delete a static route by selecting it from the list and clicking Delete.



Note: If there is no pre-configuration for non-POTS LAN connection towards the destination IP address (VoIP server and so on) via the VoIP APN, you can also do such settings using the WebUI or ACS. Then a static route for the IP address via VoIP APN should be added in the CPE.

LAN settings

From the network menu, select LAN Settings.

The LAN and LAN IPv6 menu options appear in the FastMile 5G Gateway 3.2 WebUI menu.

LAN

Click LAN

The Network/LAN Settings/LAN and Static DHCP screen appears.

Figure 42 Network: LAN settings

Network / LAN Settings / LAN

IPv4 Address	192.168.1.1
Subnet Mask	255.255.255.0
Enable DHCP	<input checked="" type="checkbox"/>
DHCP Start IP Address	192.168.1.2
DHCP End IP Address	192.168.1.254
DHCP Lease Time	1440

[Save Changes](#)

Static DHCP

MAC Address	<input type="text"/>
IPv4 Address	<input type="text"/>

[Add](#)

MAC Address	IPv4 Address	
00:0a:95:9d:68:16	192.168.1.111	Delete

You can configure the following LAN settings:

- IPv4 address
- subnet mask
- enable DHCP
- DHCP start IP address
- DHCP end IP address
- DHCP lease time
- static DHCP

Click Save Changes.



Note: Check the DHCP range before you change the LAN IP. If you want to use the LAN IP, which is included in the previous DHCP range, change the DHCP range first. Click Save. Then, change the LAN IP.

Configure a static route and bind a MAC address to a specific local LAN/IP address by entering the MAC and IP address in the static DHCP text boxes.

Click Add.

Your values appear in the table below.

Repeat for all MAC addresses to be bound.

The configured MAC and IPv4 address appear in the table below. Click Delete to remove any of the MAC address configurations.

LAN IPv6

Click LAN IPv6.

The Network/LAN settings/LAN IPv6 screen appears.

Figure 43 Network: LAN Settings: LAN IPv6



Click the switch button to enable or disable the IPv6 DHCP LAN.

Connected devices

From the network menu, select Connected Devices.

The Network/Connected Devices screen appears.

Figure 44 Network: Connected Devices

The screenshot shows a breadcrumb trail: Network / Connected Devices. There is a 'Refresh' button in the top right corner. Below is a table with the following data:

Status	Connection Type	Device Name	IPv4 Address	IPv6 Address	Hardware Address	IP Address Allocation	Lease Remaining	Last Active Time
Active	Ethernet	N-5CG6464410	192.168.0.192	fe80::2411:eb3e:7067:b428	c8:d3:ff:74:6d:41	DHCP	22 h 19 m 9 s	18/02/2021 09:53:37 AM



Note: To delete a device, disconnect the Gigabit Ethernet cable from the FastMile 5G Gateway 3.2. After a while, the Devices screen will update the number of connected devices.

Application screen

From the WebUI left-side menu, selecting Application allows you to configure the Media Server settings, port forwarding, port triggering, NTP parameters, and to enable or disable Plug and Play.

Media server

Digital Living Network Alliance (DLNA) certified devices allow you to share content between devices around a home network over a home WiFi network. You can set up the FastMile 5G Gateway 3.2 as a DLNA server and access music, video, and photos on the television.

Click Media Server.

The Media server screen appears.

Figure 45 Application: Media server/DLNA

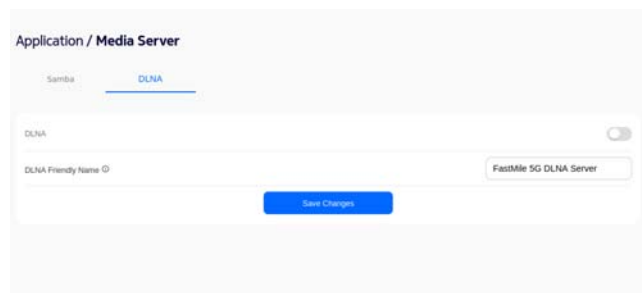

From the DLNA tab, you can configure the following settings:



Note: If the friendly name is modified when DLNA is enabled, the modification will only take effect after DLNA is disabled and then re-enabled.

- DLNA (enable/disable)
- DLNA friendly name

Click Save Changes.

You can set up the FastMile 5G Gateway 3.2 as a Samba server and local network devices (acting as Samba clients) can access the content of the USB storage. Samba provides the capability to share the USB storage by way of the SAMBA protocol to a LAN device (PC or laptop) running with an Apple, Microsoft, or Linux operating system.

To start the Linux/Mac samba clients:

Fill in the server address: `smb://192.168.1.1/usb`, as shown in [Figure 46](#).

Figure 46 Start the Linux/Mac samba client

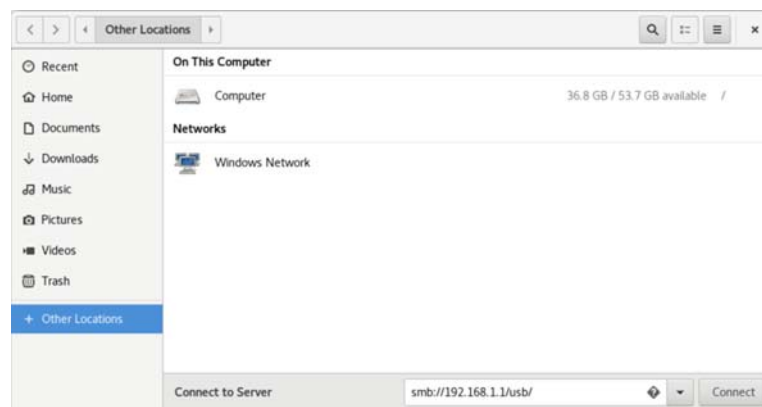

To start the Windows samba clients:

Fill in the folder path: `\\192.168.1.1\usb`, as shown in [Figure 47](#).

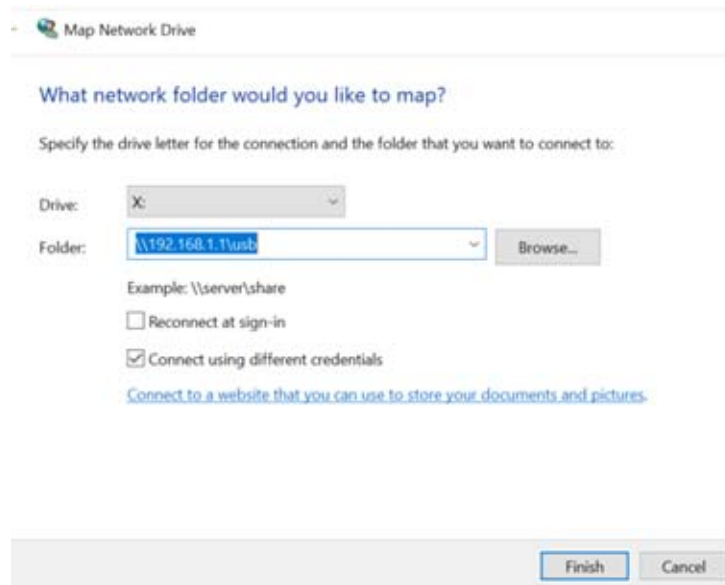
Figure 47 Start the Windows samba clients

The Samba username and password as well as the Samba enable or disable button can be configured using ACS and the WebUI.

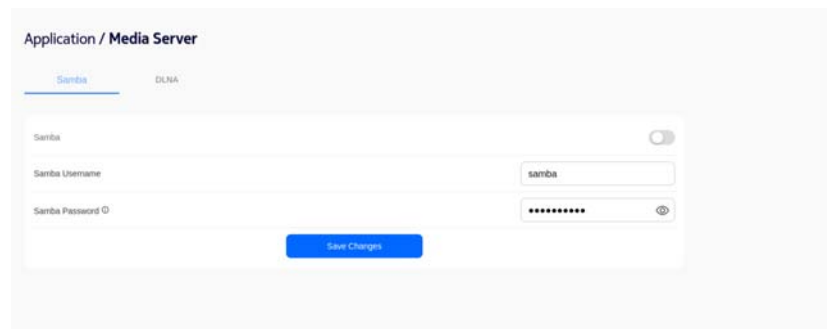
Figure 48 Application: Media server/samba

From the Samba tab, you can configure the following settings:

- Samba (enable/disable)
- Samba username: mandatory with default value samba, can be modified and set to a value that is different from 'root', and must comply with specific username rules
- Samba password: mandatory and must comply with specific password rules



Note: Samba cannot be enabled/disabled if the Samba username and password are not configured with valid values.

Samba username rules:

- uppercase characters (A-Z)
- lowercase characters (a-z)
- numbers (0-9)
- allowed special characters (underscore “_”, hyphen “-”)
- the first character of a username cannot be a special character

Samba password rules:

- use a password between a minimum of 10 and a maximum of 64 characters
- use at least 3 of the following categories:
 - uppercase characters (A-Z)
 - lowercase characters (a-z)
 - numbers (0-9)
 - allowed special characters (!#+, -./:=@_)
- the first character of a password cannot be a special character, and the same character cannot appear consecutively 8 times

Port forwarding

Click Port Forwarding.

The Port Forwarding screen appears.

Figure 49 Application: Port Forwarding

Application / Port Forwarding

Application Name Custom Settings ▾

WAN Port [] - []

LAN Port [] - []

Internal Client Custom Setti... ▾ []

Protocol TCP ▾

WAN Connection List Sgw..._TR069_INTERNET_1 ▾

[Add](#)

Application Name	WAN Connection	WAN Port	LAN Port	Device Name	Internal Client	Protocol	Status	Delete
Yahoo Messenger	Sgw..._TR069_INTERNET_1	5050-5050	5050-5050	N-SCG6464410	192.168.1.192	TCP	Active	Delete

You can configure the following settings:

- application name
- WAN Port
- LAN Port
- internal client
- protocol
- WAN connection list

Click Add.

The settings appear in the table below.

Click Delete to remove any configuration from the table.

Port triggering

Click Port Triggering.

The Port Triggering screen appears.

Figure 50 Application: Port Triggering

Application / Port Triggering

Application Name Custom Settings ▾

Open Port [] - []

Triggering Port [] - []

Expire Time 600

Open Protocol TCP ▾

Trigger Protocol TCP ▾

WAN Connection List 5gwan_TR069_INTERNET_1 ▾

[Add](#)

Application Name	WAN Connection	Open Port	Triggering Port	Expire Time	Open Protocol	Trigger Protocol	Status	Delete
Call of Duty	5gwan_TR069_INTERNET_1	28960-28960	6060-6070	600	UDP	TCP	Active	Delete

You can configure the following settings:

- application name
- open port
- triggering port
- expire time
- open protocol
- triggering protocol
- WAN connection list

Click Add.

The settings appear in the table below.

Click Delete to remove any configuration from the table.

NTP

Click NTP.

The NTP screen appears.

Figure 51 Application: NTP

Application / NTP

Enable NTP

Current Time 09/25/2020 10:20:11 PM

Primary Time Server time.nist.gov

Secondary Time Server None

Third Time Server None

Time Zone (GMT+12:00)Fiji

Save Changes

You can configure the following settings:

- enable NTP
- primary time server
- secondary time server

- third time server
- time zone

You can view the following settings:

- current time

Click Save Changes.

UPnP

Universal Plug and Play (UPnP) is a set of networking protocols that permits networked devices such as personal computers, Internet gateways, WiFi access points and mobile devices to seamlessly discover each other's presence on the network and establish functional network services.

Click UPnP.

The UPnP screen appears.

Figure 52 Application: UPnP

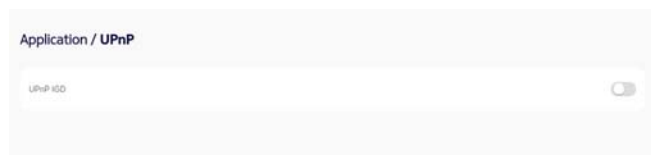

You can configure the following settings with the toggle button on the right side of the screen:

- UPnP IGD (enable/disable)

Security screen

From the WebUI left-side menu, selecting Security allows you to configure the firewall security level, IP filter parameters, and ALG/DMZ.

Firewall

The firewall security level only applies to services provided by the FastMile 5G Gateway 3.2.

The following firewall security levels can be configured for the FastMile 5G Gateway 3.2:

- off: all inbound and outbound traffic is allowed
- low: all outbound traffic and pinhole-defined inbound traffic is allowed
- high: all inbound traffic is denied and only minimal common outbound services are permitted

Click Firewall.

The Firewall screen appears.

Figure 53 Security: Firewall

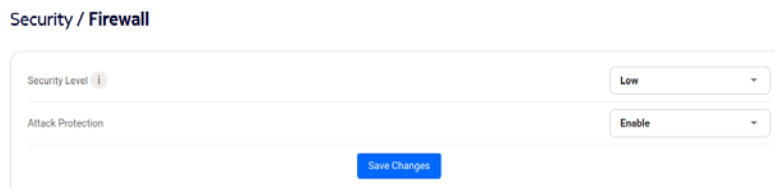

Security / Firewall

Security Level

Attack Protection

[Save Changes](#)

You can configure the following firewall settings:

- security level (off, low, or high)
- attack protection (enable/disable)

Click Save Changes.

IP filter

Click IP Filter.

The IP Filter screen appears.

Figure 54 Security: IP Filter

Security / IP Filter

Enable IP Filter

Mode Drop for upstream ▾

Internal Client Custom settings ▾

Local IP Address

Source Subnet Mask

Remote IP Address

Destination Subnet Mask

Protocol ALL ▾

[Save Changes](#)

Mode	Internal Client	Protocol	Local IP Address	Source Subnet Mask	Remote IP Address	Destination Subnet Mask	Wan Port Range	Lan Port Range	Delete
Drop for upstream	N-5CG6464410	FTP	192.168.1.192				TCP: 21UDP: 0		Delete

You can configure the following IP filter settings:

- enable IP filter
- mode
- internal client
- local IP address
- source subnet mask
- remote IP address
- destination subnet mask
- protocol

Click Save Changes.

Click Delete to remove any configuration from the table.

ALG and DMZ screen

From the WebUI left-side menu, selecting DMZ/ALG allows you to configure Application-Level Gateway (ALG) and Demilitarize Zone (DMZ) parameters.

Click DMZ/ALG.

The ALG Configuration and DMZ Configuration screen appears.

Figure 55 Security: DMZ/ALG

ALG Configuration

FTP	<input checked="" type="checkbox"/>
TFTP	<input checked="" type="checkbox"/>
SIP	<input checked="" type="checkbox"/>
H323	<input checked="" type="checkbox"/>
RTSP	<input checked="" type="checkbox"/>
L2TP	<input checked="" type="checkbox"/>
IPSEC	<input checked="" type="checkbox"/>
PPTP	<input checked="" type="checkbox"/>

DMZ Configuration

WAN Connection List: Sgwan_TR069_INTERNET_1

DMZ IP Address: Custom Sett... 0.0.0.0

Enable DMZ:

You can enable or disable the following ALG settings:

- FTP
- TFTP
- SIP
- H323
- RTSP
- L2TP
- IPSEC
- PPTP

Click Save Changes.

You can configure the following DMZ settings:

- WAN connection list
- DMZ IP address

- enable DMZ

Click Save Changes.

Diagnostics screen

From the WebUI left-side menu, selecting Diagnostics allows you to configure log settings and perform speed tests by Ookla.

Logs

Click Logs.

The Logs screen appears.

Figure 56 Diagnostics

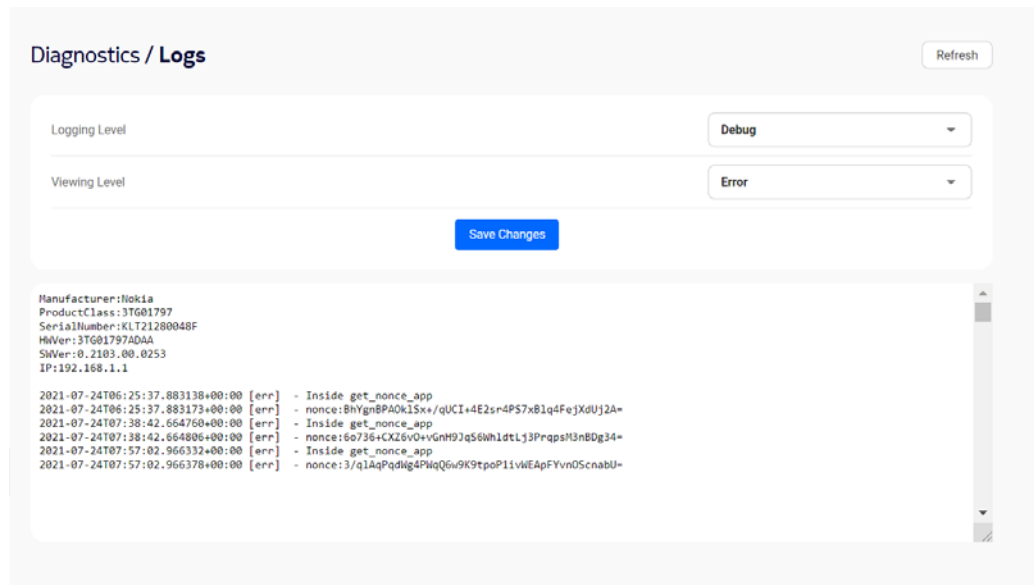

Choose a logging level from the drop-down menu to determine the types of events that are recorded in the log file.

Choose the viewing level from the drop-down menu to determine the types of events that are shown in the log file.

Click Save Changes. The log file is displayed at the bottom of the screen.

Speed test by Ookla

The FastMile 5G Gateway 3.2 supports two WAN types: cellular and Ethernet.

If the WAN parameter type is configured for Cellular WAN type, then the Cellular WAN type speed test results will be displayed in the WebUI.

If the WAN parameter type is configured for Ethernet WAN type, then the Ethernet WAN type speed test results will be displayed in the WebUI.

Figure 57 Diagnostics: Speed Test by Ookla with Cellular WAN type

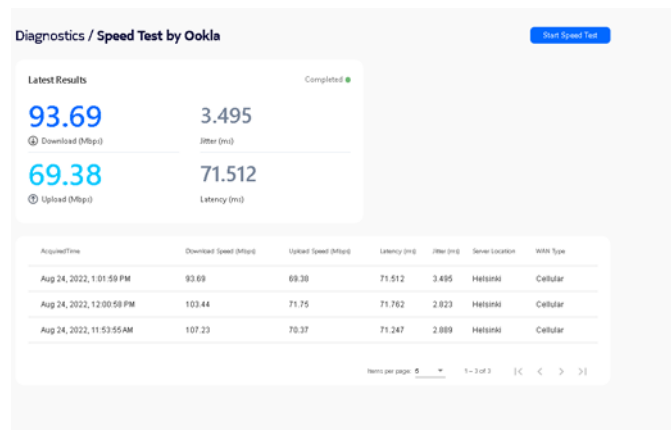
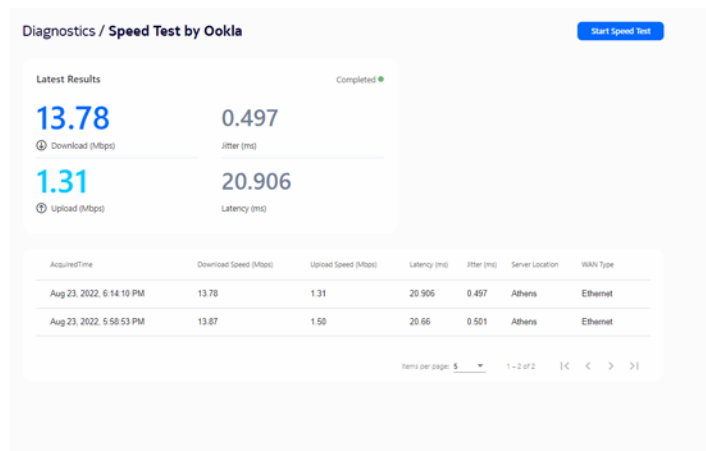

Figure 58 Diagnostics: Speed Test by Ookla with Ethernet WAN type



Click Speed Test by Ookla.

Click Start Speed Test. You should be prompted to agree to use this speed test service by Ookla as per their privacy policy.

The Speed Test screen appears.

Click the Start Speed Test button. The test may take up to 45 seconds to complete.

The Speed Test results will display the following parameter information:

- acquired time
- download speed (Mbps)
- upload speed (Mbps)
- latency (ms)
- jitter (ms)
- server location
- WAN type

System screen

The system screen has the following tabs:

- General
- Device Management
- LED Management

General

From the WebUI left-side menu, selecting System and then General will show you these options:

- enter PIN to unlock your SIM card
- enter PUK and PIN to unblock your SIM card
- reboot device: the device restarts and keeps existing configuration
- factory reset: the device restarts and erases existing configuration
- change password



Note: For a PIN-locked SIM card after reboot, or factory reset, a PIN number will be needed. Also, if a second SIM card B is used with PIN enabled and inserted to the CPE and its PIN is verified, the SIM card A PIN number will be needed when it is inserted.

For uSIM cards, when status shows *Available* it means PIN number verification is needed. When status shows *Blocked* it means the SIM PIN is blocked and you need to input a PUK number and a new PIN number. When status shows *Error* it means the SIM card is disabled because of a PUK error, or a modem failure, or a broken SIM card, or a specific PIN lock acceptance feature is not active but the SIM card PIN number is locked.

Unlocking or unblocking your SIM card

A SIM PIN number is defined by default and provided in a SIM plastic envelope.

If your PIN is locked, from the System General screen, click Enter PIN to unlock your SIM card.

Figure 59 **Unlock your SIM card**



The Enter PIN to unlock SIM entry box will appear. Enter your PIN number.

Figure 60 **Enter PIN to unlock your SIM card**

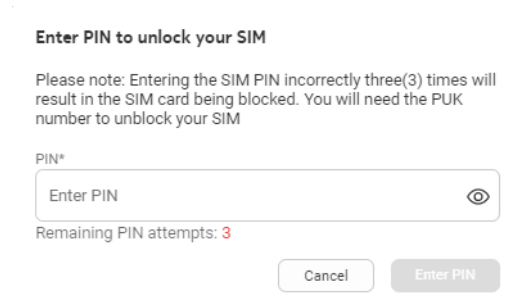

Entering the SIM PIN incorrectly 3 times will result in the SIM card being blocked.

If your SIM card is blocked, from the System General screen click Enter PUK to unblock your SIM card.

Figure 61 Unblock your SIM card



The Enter PUK to unblock your SIM card entry box will appear. Enter your PUK and PIN numbers.

Figure 62 Enter PUK and PIN to unblock your SIM card

Enter PUK to unblock your SIM

Please note: Entering the SIM PUK incorrectly ten(10) times will result in the SIM card being disabled. You will need to contact your operator to enable your SIM card.

PUK*

Remaining PUK attempts: 8

New PIN*

Confirm new PIN*

Entering the SIM PUK number incorrectly 10 times will result in the SIM card being disabled. You will need to contact your operator to enable the SIM card.

Rebooting the FastMile 5G Gateway 3.2

Rebooting the FastMile 5G Gateway 3.2 cycles power to the device and keeps all configurations made to date.

Using the WebUI

From the System, General screen, click Reboot.

The FastMile 5G Gateway 3.2 reboots and keeps existing configuration parameters.

Resetting the FastMile 5G Gateway 3.2 to factory default

Resetting the FastMile 5G Gateway 3.2 to factory default removes all configurations made to date.

Using the WebUI

From the System, General screen, click Reset.

The FastMile 5G Gateway 3.2 restarts and erases existing configuration.

Changing the password



Note: For security reasons, it is recommended to change the default password once you have logged into the WebUI.

Passwords must contain 10-64 characters. The first character of the password cannot be a special character. The same character cannot be used consecutively eight times.

Passwords must have at least three of the following four types of characters:

- uppercase character (A-Z)
- lowercase character (a-z)
- number (0-9)
- special character (!#+, -/:=@_)

From the System, General screen, click Change Password.

The Change Password screen appears.

Figure 63 System: Change Password

Change Password

Please note: The only way to restore a lost password is via factory reset

Current Password

New Password

10-64, must start with a letter or number and must contain three out of four of the following categories: upper case, lower case, numbers, special characters !#+,-./:=@_

Confirm Password

Enter the current password, located on the product label.

Enter the new password again to confirm.

Click Update Password.

Your password is changed.

Device management

Click Device management.

The Device Management screen appears.

Figure 64 System: Device Management

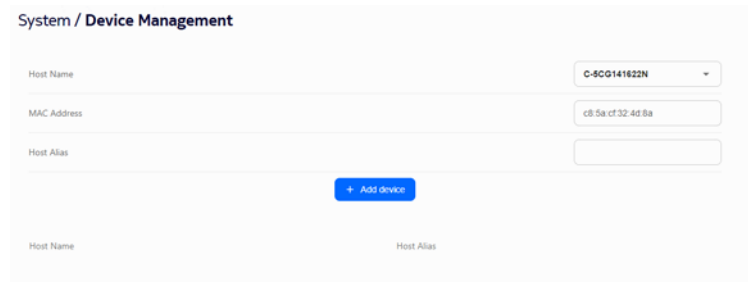

You can configure the following device management settings:

- host name
- MAC address
- host alias

Click Add device.

The values appear in the table below.

LED management

Click LED management.

The LED Management screen appears.

Figure 65 System: LED Management

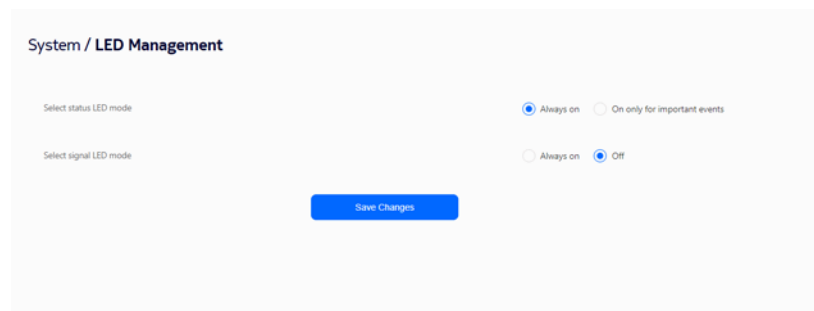

You can configure the following LED management settings:

- select signal LED mode

-
- select status LED mode

Click Save Changes.

Logging out

Click Logout from the bottom of the FastMile 5G Gateway 3.2 menu.

Troubleshooting

This section provides additional information about:

- understanding LED colors
 - status LED
 - 5G LED
 - signal strength LEDs
- using the signal test button
- repositioning for a better signal
- using the power button
- using the reset button

Understanding the LED colors

The LEDs, on the top of the gateway, allow you to locate the FastMile 5G Gateway 3.2 in the best location for 4G/LTE or 5G signal reception.

You can check the signal strength at any time by pressing the signal test button on the side of the FastMile 5G Gateway 3.2. See [Using the signal test button](#) for the procedure.

Use the status LED table to check the LED behavior and perform the actions to resolve issues.

Figure 66 Status LEDs

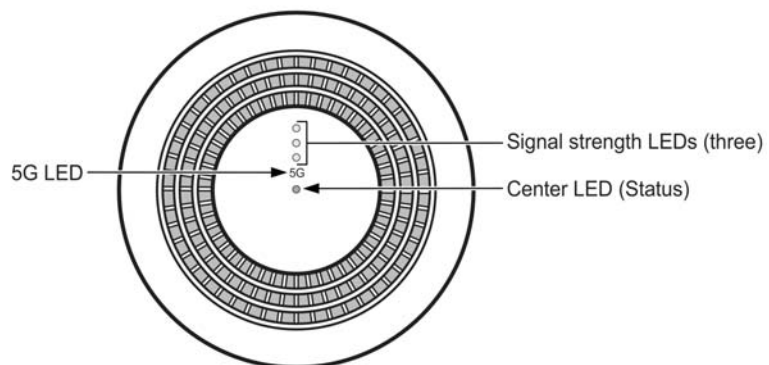

37271



Note: LED indications can change over time due to variable 4G/LTE and or 5G signal conditions.

If the thresholds have been changed during pre-configuration, the LED indications will be different.

Status LED

The Status LED indicates the status of the FastMile 5G Gateway 3.2 device.

Table 2 Status LED

LED color	LED behavior	What it means	What you may consider doing
White	Slow blinking	WPS pairing in progress or reset button pressed longer than 5 - 30 seconds which will trigger factory reset	Do nothing
White	Fast blinking	WPS pairing successful or reset button pressed longer than 30 seconds which will trigger factory reset	Do nothing
		Software upgrade is ongoing	Caution: do not turn off the device
Yellow	Blinking	Start up	Do nothing
Red	Slow blinking	Missing SIM card	Insert the SIM card, see Inserting the SIM card
		or SIM card is broken or is not being recognized by the CPE	Replace the SIM card
		or SIM card is PIN-locked	Enter correct PIN number using the WebUI, see Unlocking or unblocking your SIM card
		or SIM card is PUK-locked	Enter correct PUK number using the WebUI, see Unlocking or unblocking your SIM card
Red	Fast blinking	Reset to factory default settings	Factory reset in progress
Red	Solid	No 4G/LTE or 5G connection Or Some applications in abnormal state.	Consider moving the gateway Power Off/On

Table 2 Status LED (Continued)

LED color	LED behavior	What it means	What you may consider doing
Green	Solid	Signal test in progress. 4G/LTE, or 5G, or Ethernet WAN connection 1	Do nothing
Green	Blinking	Ethernet WAN is down and the device is switching back to wireless WAN, or wireless WAN is down and the device is switching back to Ethernet WAN	Do nothing

1. For Ethernet WAN connection: the 5G LED and Signal LEDs have no meaning and would be off.
For Ethernet WAN: the cellular WAN switch duration is indicated with blinking green LED.

5G LED

The white 5G LED indicates 4G or 5G service availability while a signal test is in progress. By default, the 5G LED and three signal LEDs are off. The status LED is green during the device's normal state.

The 5G LED will be on if the network is 5G, otherwise the 5G LED will be off if the network is 4G.

When the signal test button is pressed, the 5G LED and the three signal LEDs blink fast for a few seconds, then the 5G LED will be on for five seconds if the network is 5G or will be off if the network is 4G.

The signal LED will be on according to the cell strength. The 5G LED and signal LED turn off after the signal test (five seconds, which is the default).

Table 3 5G LED

LED behavior	When	What you may consider doing
Blinks	Signal test in progress and during start up	Do nothing
Not lit	4G is available while signal test in progress	Do nothing
Lit	5G is available while signal test in progress	Do nothing



Note: In 5G NSA (option 3x), the 5G LED will be off during the signal test if the FastMile 5G Gateway 3.2 is in idle state, even if 5G service is available.

Signal strength LED

There are three LEDs to indicate signal strength. These signal LEDs blink during start-up and at the start of a signal test.

See [Understanding the LED colors](#) for a description of the signal strength LED. The number of lit LEDs indicate the signal strength. For example, three means a very strong signal.

Using the signal test button

You can check and test the signal strength at any time by pressing the signal test button on the side of the FastMile 5G Gateway 3.2 to check the LEDs and perform corrective actions.

Figure 67 Location of signal test button

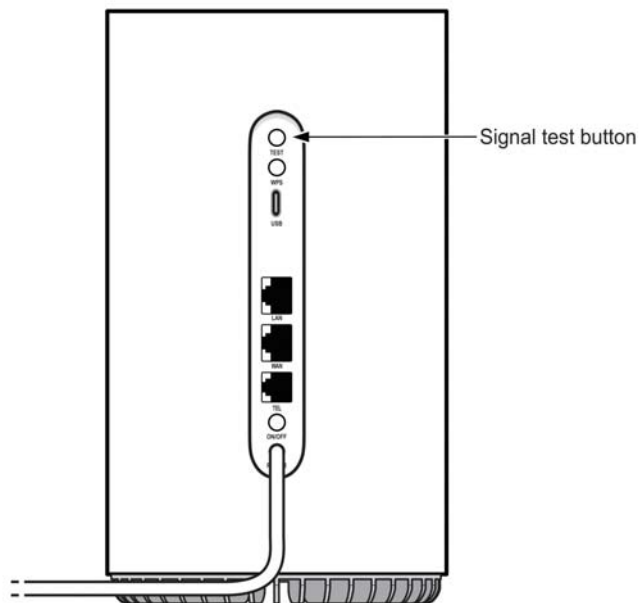

37272



Note: Once you have a good 4G/LTE or 5G connection, it is recommended that you do not relocate or rotate your device. It is strongly recommended that you position your device near a window, where the best 4G/LTE or 5G signal is expected.

However, the omni-directional antenna is less susceptible to Internet speed changes when rotating the device since it does not have a directional antenna.

Rotating your device may still influence the Internet speeds due to indoor signal reception conditions.

Table 4 Signal strength LED

LED	LED behavior	Meaning	What you may consider doing
5G and all three-signal strength	Lit Lit	Good 5G connection	Do nothing
5G and all three-signal strength	Not lit Lit	Good 4G/LTE connection	Do nothing
5G and two-signal strength	Lit Lit	Medium 5G connection	Consider moving the gateway
5G and two-signal strength	Not lit Lit	Medium 4G/LTE connection	Consider moving the gateway
5G and one-signal strength	Lit Lit	Weak 5G connection	Consider moving the gateway
5G and one-signal strength	Not lit Lit	Weak 4G/LTE connection	Consider moving the gateway
Center and all three-signal strength	Red (solid) Not lit	No 4G/LTE No 5G connection	Move the gateway

Repositioning for a better signal

After performing the [Using the signal test button](#) procedure to determine the quality of signal, you may want to reposition the FastMile 5G Gateway 3.2 for a better signal, do the following:

- power off the FastMile 5G Gateway 3.2
- disconnect the FastMile 5G Gateway 3.2 from the electrical outlet

- move the FastMile 5G Gateway 3.2 to a different position, for example, the other side of the room or a higher position
- connect the FastMile 5G Gateway 3.2 to an electrical outlet at the new location and power it on
- check the LEDs as described in [Understanding the LED colors](#) to determine the quality of signal in the new position and follow the actions you may consider in the section



Note: You may need to repeat the steps several times before finding the final location for the FastMile 5G Gateway 3.2.

Once you have a good signal, it is important that you do not reposition or rotate the FastMile 5G Gateway 3.2. You are now ready to connect devices to your FastMile 5G Gateway 3.2.

The LED behavior table provides helpful actions to perform when the FastMile 5G Gateway 3.2 LED has the following behavior.

Table 5 LED behavior requiring action

Status LED (3 color) behavior	5G LED (single color)	Signal strength LEDs (multiple one color)	Reason	Action
Blinking slowly (red)	Off	Off	Missing SIM card, or SIM card is PIN-locked, or SIM card is bad and could not be recognized by the CPE	Replace SIM or reinstall (it is recommended to replace a SIM card with a new PIN-locked SIM card)
Solid (red)	Off	Off	No radio link or No Internet	Consider moving gateway

Using the power button

The power button is located on the backside of the FastMile 5G Gateway 3.2 and is marked on/off.

Press the power button for one second (off), wait one second, and then press the power button again (on).

The FastMile 5G Gateway 3.2 reboots.

Using the reset button

Reset the device by pressing the reset button for 5 seconds or more. The reset button is located on the label on the bottom of the device.

Figure 68 Location of reset button

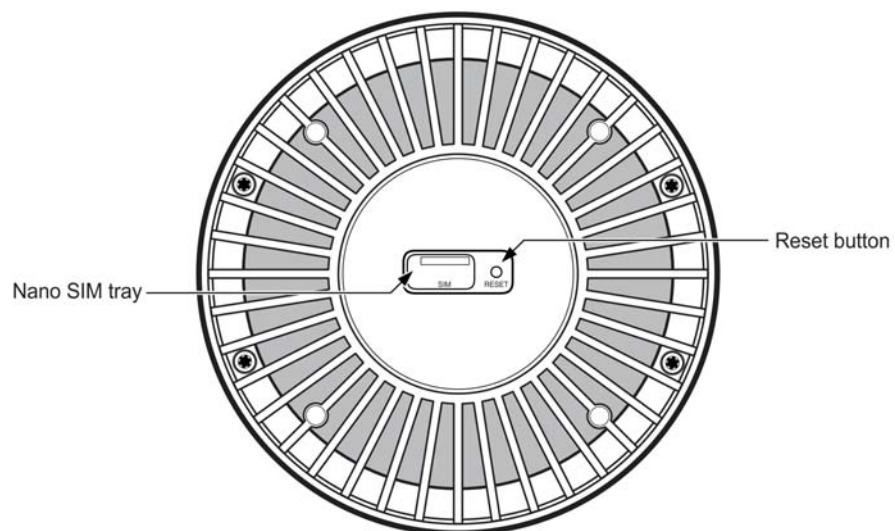

37277



Note: During factory reset, the FastMile 5G Gateway 3.2 could restart twice. This is normal behavior.

Glossary

This glossary provides the explanation and optional descriptions of most acronyms and initialisms that appear in this document.

3GPP	3 rd Generation Partnership Project
4FF	4 th Form Factor
AC	Alternating Current
ALG	Application-level Gateway
AP	Access Point
APN	Access Point Name
CA	Carrier Aggregation
CB	Certification Body
CE	Conformité Européenne (European Health and Safety product label)
DMZ/ALG	Demilitarized Zone/Application-Level Gateway
DHCP	Dynamic Host Configuration Protocol
DLNA	Digital Living Network Alliance
EN-DC	E-UTRAN New Radio - Dual Connectivity
EARFCN	E-UTRA Absolute Radio Frequency Channel Number
GCF	The Global Certification Forum
GITEKI	Japan's Ministry of Internal Affairs and Communications (MIC) for the Radio Act and for the Electronic Communications Business Act. (also known as the Telecom Engineering Center certification (TELEC))
IMSI	International Mobile Subscriber Identity
IP	International Protection or Internet Protocol
IPv6	Internet Protocol version 6
ISED	Innovation, Science and Economic Development regulations
JATE	Japan Approvals Institute for Telecommunications Equipment
LED	Light Emitting Diode
LTE	Long Term Evolution
MIMO	Multiple-Input Multiple-Output
MU-MIMO	Multi-User Multiple-Input Multiple Output
NR	New Radio
NR-ARFCN	New Radio Absolute radio-frequency channel number
NSA	Non-Standalone
NTP	Network Time Protocol
NWCC	Nokia WiFi Cloud Controller

PCI	Peripheral Component Interconnect
POTS	Plain Old Telephone Service
PSE	Japan Product Safety Electrical Appliance and Material
QSG	Quick Start Guide
RF	Radio Frequency
RRM	Radio Resource Management
RSRP	Reference Signal Received Power
RSRQ	Reference Signal Received Quality
SA	Service Affecting or Standalone
SIM	Subscriber Identify Module
SNR	Signal to Noise Ratio
SSID	Service Set identifier
UL	Up link
UPnP	Universal Plug and Play
USB	Universal Serial Bus
VDC	Volts Direct Current
WAN	Wide Area Network
WebUI	Graphic User Interface
WiFi	Wireless Fidelity
WLAN	Wireless Local Area Network
WPS	WiFi Protected Setup

Technical specifications

There are three FastMile 5G Gateway 3.2 models available as follows:

- Model 5G13-12W-A
- Model 5G15-12W-A
- Model 5G16-12W-A

Model 5G13-12W-A

Model: 5G13-12W-A	Kit part number: <ul style="list-style-type: none"> • 3TG-01889-AA
	Device part number on bottom label: <ul style="list-style-type: none"> • 3TG-01797-AD
Dimensions	Diameter 125 mm (4.9 in) x Height 218.5 mm (8.6 in) Weight 1014 g (2.235 lbs) without the power adapter
Certifications	GEM, PSE, VCCI, GITEKI, and WFA
Operating environment	-5°C to 40°C (23°F to 104°F) Indoor use only. Device is capable of operation up to 45°C (113°F) with reduced performance
Operating humidity	5% to 85%, non-condensing
Short-term humidity	5% to 93%, non-condensing
Storage temperature	-40°C to 70°C (-40°F to 158°F)
SIM card	4FF/nano-sized SIM slot eSIM support for specific customer agreement
Power	12V DC power adapter consumption: < 30 W
Interior antennas	Omni-directional antenna:
4G/LTE Gain	Up to 4 dBi depending on LTE band
5G	Up to 4 dBi depending on 5G RF band
Radio frequency safety distance	20 cm (7.8 inches)

Model 5G15-12W-A

Model: 5G15-12W-A	Kit part number: <ul style="list-style-type: none"> • 3TG-01798-AA • 3TG-01798-AB • 3TG-01798-AC • 3TG-01798-AG • 3TG-01798-AH • 3TG-01798-AK • 3TG-01798-AM 	Device part number on bottom label: <ul style="list-style-type: none"> • 3TG-01797-AK • 3TG-01797-AA • 3TG-01797-AB • 3TG-01797-AB • 3TG-01797-AB • 3TG-01797-AH • 3TG-01797-AM • 3TG-01797-AH
Dimensions	Diameter 125 mm (4.9 in) x Height 218.5 mm (8.6 in) Weight 1014 g (2.235 lbs) without the power adapter	
Certifications	CE, CB, GCF, RCM and WFA	
Operating environment	-5°C to 40°C (23°F to 104°F) Indoor use only Device is capable of operation up to 45°C (113°F) with reduced performance	
Operating relative humidity	5% to 85%, non-condensing	
Short-term relative humidity	5% to 93%, non-condensing	
Storage temperature	-40°C to 70°C (-40°F to 158°F)	
SIM card	4FF/nano-sized SIM slot eSIM support for specific customer agreement Notes: 3TG-01798-AC (3TG-01797-AB): eSIM profile is not programmed in factory, so the device must always rely on the nano-SIM card. In case eSIM is expected to be used, please contact your Nokia representative for details. 3TG-01798-AG (3TG-01797-AB): eSIM profile is programmed in factory, activation of profile is possible with the provided ICCID information on the device label. End-user can choose to activate the eSIM or use a nano-SIM card.	
Power	12V DC power adapter consumption: < 30 W	
3TG-01798-AB/AC/AG/AH/AM	12V DC power adapter consumption: < 48 W	
Power	12V DC power adapter consumption: < 48 W	
3TG-01798-AA/AK	12V DC power adapter consumption: < 48 W	

Interior antennas 3TG-01798-AB/AC/AG/AH/AM	Omni-directional antenna:
4G/LTE gain	Up to 7.6 dBi depending on LTE band
5G	Up to 7.6 dBi depending on 5G RF1 band
Interior antennas 3TG-01798-AA/AK	Omni-directional antenna:
4G/LTE gain	Up to 6 dBi depending on LTE band
5G	Up to 7.6 dBi depending on 5G RF1 band
Radio frequency safety distance 3TG-01798-AB/AC/AG/AH/AM	20 cm (7.8 inches)
Radio frequency safety distance 3TG-01798-AA/AK	30 cm (12 inches)

Model 5G16-12W-A

Model: 5G16-12W-A	Kit part number: • 3TG-01799-AA
	Device part number on bottom label: • 3TG-01797-AC
Dimensions	Diameter 125 mm (4.9 in) x Height 218.5 mm (8.6 in) Weight 1014 g (2.235 lbs) without the power adapter
Certifications	FCC, ISED, ETL, WFA
Operating environment	-5°C to 40°C (23°F to 104°F) Indoor use only Device is capable of operation up to 45°C (113°F) with reduced performance
Operating relative humidity	5% to 85%, non-condensing
Short-term relative humidity	5% to 93%, non-condensing
Storage temperature	-40°C to 70°C (-40°F to 158°F)
SIM card	4FF/nano-sized SIM slot eSIM support for specific customer agreement
Power	12V DC power adapter consumption: < 48 W
Interior antennas	Omni-directional antenna:
4G/LTE gain	Up to 6.7 dBi depending on LTE band
5G	Up to 6.7 dBi depending on 5G RF band
Radio frequency safety distance	US: 29 cm (12 inches) CAN: 35 cm (14 inches)

4G / LTE radio frequency specifications

Table 6 Supported 4G/LTE radio frequency per FastMile 5G Gateway 3.2 model

FastMile 5G Gateway 3.2 model	Supported 4G/LTE radio frequency	
5G13-12W-A		
radio bands for LTE (TDD)	B41	2496-2690 MHz
5G15-12W-A - support for variants 3TG-01798-AB/AC/AG/AH/AM		
radio bands for LTE (FDD)	B1	UL: 1920-1980 MHz DL: 2110-2170 MHz
	B3	UL: 1710-1785 MHz DL: 1805-1880 MHz
	B5	UL: 824 -849 MHz DL: 869 - 894 MHz
	B7	UL: 2500-2570 MHz DL: 2620-2690 MHz
	B8	UL: 880-915 MHz DL: 925-960 MHz
	B20	UL: 832-862 MHz DL: 791-821 MHz
	B28	UL: 703-748 MHz DL: 758-803 MHz
	B32	DL: 1452-1496 MHz
radio bands for LTE (TDD)	B38	2570-2620 MHz
	B40	2300-2400 MHz
	B41	2496-2690 MHz
	B42	3400-3600 MHz
	B43	3600-3800 MHz
5G15-12W-A - support for variant 3TG-01798-AA		

Table 6 Supported 4G/LTE radio frequency per FastMile 5G Gateway 3.2 model (Continued)

FastMile 5G Gateway 3.2 model		Supported 4G/LTE radio frequency
radio bands for LTE (FDD)	B1	UL: 1920-1980 MHz; DL: 2110-2170 MHz
	B3	UL: 1710-1785 MHz; DL: 1805-1880 MHz
	B5	UL: 824 -849 MHz; DL: 869 - 894 MHz
	B7	UL: 2500-2570 MHz; DL: 2620-2690 MHz
	B8	UL: 880-915 MHz; DL: 925-960 MHz
	B28	UL: 703-748 MHz; DL: 758-803 MHz
radio bands for LTE (TDD)	B40	2300-2400 MHz
	B41	2496-2690 MHz
5G15-12W-A - support for variant 3TG-01798-AK		
radio bands for LTE (FDD)	B1	UL: 1920-1980 MHz; DL: 2110-2170 MHz
	B3	UL: 1710-1785 MHz; DL: 1805-1880 MHz
	B5	UL: 824 -849 MHz; DL: 869 - 894 MHz
	B7	UL: 2500-2570 MHz; DL: 2620-2690 MHz
	B8	UL: 880-915 MHz; DL: 925-960 MHz
	B28	UL: 703-748 MHz; DL: 758-803 MHz
5G16-12W-A		

Table 6 Supported 4G/LTE radio frequency per FastMile 5G Gateway 3.2 model (Continued)

FastMile 5G Gateway 3.2 model		Supported 4G/LTE radio frequency
radio bands for LTE (FDD)	B1	UL: 1920-1980 MHz DL: 2110-2170 MHz
	B2	UL: 1850-1910 MHz DL: 1930-1990 MHz
	B3	UL: 1710-1785 MHz DL: 1805-1880 MHz
	B4	UL: 1710-1755 MHz DL: 2110-2155 MHz
	B5	UL: 824 -849 MHz DL: 869 - 894 MHz
	B7	UL: 2500-2570 MHz DL: 2620-2690 MHz
	B12	UL: 699 -716 MHz DL: 729 - 746 MHz
	B13	UL: 777 -787 MHz DL: 746 - 756 MHz
	B25	UL: 1850 -1915 MHz DL: 1930- 1995 MHz
	B66	UL: 1710-1780 MHz DL: 2110-2200 MHz
radio bands for LTE (TDD)	B71	UL: 663-698 MHz DL: 617-652 MHz
	B38	2570-2620 MHz
	B41	2496-2690 MHz
	B42	3400-3600 MHz
	B43	3600-3800 MHz
	B46	(LAA): 5150-5925 MHz
B48	3550-3700 MHz	

5G NR radio frequency specifications



Note: In compliance with 3GPP Release 15 - 5G NR NSA: Option 3X, Option 3A and SA: Option 2.

Table 7 Supported 5G NR radio frequency per FastMile 5G Gateway 3.2 model

FastMile 5G Gateway 3.2 model	Supported 5G NR radio frequency	
5G13-12W-A		
radio bands for sub-6 GHz (TDD)	n41	2496-2690 MHz
	n79	4400 - 5000 MHz
5G15-12W-A - support for variants 3TG-01798-AB/AC/AG/AH/AM		
radio bands for sub-6 GHz (FDD)	n1	UL: 1920-1980 MHz; DL: 2110-2170 MHz
	n3	UL: 1710-1785 MHz; DL: 1805-1880 MHz
	n5	UL: 824 -849 MHz; DL: 869 - 894 MHz
	n7	UL: 2500-2570 MHz DL: 2620-2690 MHz
	n8	UL: 880-915 MHz; DL: 925-960 MHz
	n20	UL: 832-862 MHz; DL: 791-821 MHz
	n28	UL: 703-748 MHz; DL: 758-803 MHz
radio bands for sub-6 GHz (TDD)	n38	2570-2620 MHz
	n40	2300-2400 MHz
	n41	2496-2690 MHz
	n78	3300-3800 MHz
5G15-12W-A - support for variant 3TG-01798-AA		

Table 7 Supported 5G NR radio frequency per FastMile 5G Gateway 3.2 model

FastMile 5G Gateway 3.2 model		Supported 5G NR radio frequency
radio bands for sub-6 GHz (FDD)	n1	UL: 1920-1980 MHz; DL: 2110-2170 MHz
	n3	UL: 1710-1785 MHz; DL: 1805-1880 MHz
	n5	UL: 824 -849 MHz; DL: 869 - 894 MHz
	n7	UL: 2500-2570 MHz; DL: 2620-2690 MHz
	n8	UL: 880-915 MHz; DL: 925-960 MHz
	n28	UL: 703-748 MHz; DL: 758-803 MHz
radio bands for sub-6 GHz (TDD)	n40	2300-2400 MHz
	n41	2496-2690 MHz
	n78	3300-3800 MHz)
5G15-12W-A - support for variant 3TG-01798-AK		
radio bands for sub-6 GHz (FDD)	n1	UL: 1920-1980 MHz; DL: 2110-2170 MHz
	n3	UL: 1710-1785 MHz; DL: 1805-1880 MHz
	n5	UL: 824 -849 MHz; DL: 869 - 894 MHz
	n7	UL: 2500-2570 MHz; DL: 2620-2690 MHz
	n8	UL: 880-915 MHz; DL: 925-960 MHz
	n28	UL: 703-748 MHz; DL: 758-803 MHz
radio bands for sub-6 GHz (TDD)	n78	3300-3800 MHz)
5G16-12W-A		

Table 7 Supported 5G NR radio frequency per FastMile 5G Gateway 3.2 model

FastMile 5G Gateway 3.2 model		Supported 5G NR radio frequency
radio bands for sub-6 GHz (FDD)	n1	UL: 1920-1980 MHz; DL: 2110-2170 MHz
	n2	UL: 1850-1910 MHz; DL: 1930-1990 MHz
	n3	UL: 1710-1785 MHz; DL: 1805-1880 MHz
	n5	UL: 824 -849 MHz; DL: 869 - 894 MHz
	n7	UL: 2500-2570 MHz; DL: 2620-2690 MHz
	n12	UL: 699-716 MHz; DL: 729-746 MHz
	n25	UL: 1850-1915 MHz; DL: 1930 -1995 MHz
	n66	UL: 1710-1780 MHz; DL: 2110-2200 MHz
	n71	UL: 663-698 MHz; DL: 617-652 MHz
radio bands for sub-6 GHz (TDD)	n38	2570-2620 MHz
	n41	2496-2690 MHz
	n48	3550-3700 MHz
	n77	3300-4200 MHz
	n78	3300-3800 MHz



Note: Actual supported radio frequency (RF) bands may vary in different regions due to certifications.

Antenna gains

Table 8 Antenna gains per FastMile 5G Gateway 3.2 model

FastMile 5G Gateway 3.2 model		Antenna gains
4G / LTE antenna gains		
5G13-12W-A	B41	0.5 to 4 dBi
5G15-12W-A For 3TG-01798-AB/AC/AG/AH/AM variants	B42	4.5 to 7.5 dBi
	B43	
	B7 B38 B40 B41	2.5 to 6 dBi
	B1 B3	2 to 6 dBi
	B32	3.5 to 6 dBi
	B5 B8 B20 B28	0.5 to 3 dBi
5G15-12W-A For 3TG-01798-AA variant	B7 B40 B41	2.5 to 6 dBi
	B1 B3	2 to 6 dBi
	B5 B8 B28	0.5 to 3 dBi
5G15-12W-A For 3TG-01798-AK variant	B1 B3	2 to 6 dBi
	B5 B8 B28	0.5 to 3 dBi
	B7	2.5 to 6 dBi

Table 8 Antenna gains per FastMile 5G Gateway 3.2 model

FastMile 5G Gateway 3.2 model		Antenna gains
5G16-12W-A	B46	4.6 to 6.7 dBi
	B42 B43 B48	4.9 to 6.6 dBi
	B7 B38 B41	3.4 to 6 dBi
	B1 B2 B3 B4 B25 B66	2 to 5.2 dBi
	B5 B12 B13 B26 B71	0.7 to 3 dBi
Device built in 5G NR antenna gains		
5G13-12W-A	n41	0.5 to 4 dBi
	n79	0.5 to 3 dBi
5G15-12W-A	n78	4.5 to 7.6 dBi
	n7 n38 n40 n41	4 to 6 dBi
	n1 n3	2 to 6 dBi
	n5 n8 n20 n28	0.5 to 3 dBi

Table 8 Antenna gains per FastMile 5G Gateway 3.2 model

FastMile 5G Gateway 3.2 model		Antenna gains
5G16-12W-A	n48 n77 n78	4.9 to 6.6 dBi
	n7 n38 n41	3.4 to 6 dBi
	n1 n2 n3 n25 n66	2 to 5.2 dBi
	n5 n12 n71	0.7 to 3 dB

WiFi

The device is also compliant with 802.11b/g/n/ax 2.4 GHz, and 802.11a/n/ac/ax 5 GHz.

The device supports up to 64 clients per band and per service set identifier (SSID).

5G NSA mode

The FastMile 5G Gateway 3.2 implements the 5G NSA (Option 3x, Option 3) configuration, meaning it uses a 4G/LTE carrier and 5G NSA carrier at the same time to connect to the service provider's network. The control plane is carried over the LTE network and the user plane is carried over both the LTE and 5G NSA networks.

5G SA

When operating in the 5G SA mode (Option 2), the FastMile 5G Gateway 3.2 uses the 5G network to connect to the service provider's network.

Warranty and safety

For information on the hardware limited warranty, please go to www.nokia.com/fastmile. Read the FastMile 5G Gateway 3.2 safety and regulatory information that is included with the product for the following information:

- safety warnings (risk of electrical shock or fire)
- caution (potential equipment damage)
- environmental and regulatory requirements
- end of life collection and treatment
- simplified EC declaration or conformity
- specific precautions for EMS warnings

Manufacturer information

Table 9

Manufacturer	Nokia Solutions & Networks Oyj www.nokia.com
Address	Karakaari 7, 02610 Espoo, Finland
Customer support	Contact your service provider where you purchased the device.

About Nokia

We create the technology to connect the world. Powered by the research and innovation of Nokia Bell Labs, we serve communications service providers, governments, large enterprises and consumers, with the industry's most complete, end-to-end portfolio of products, services and licensing.

From enabling infrastructure for 5G and the Internet of Things, to emerging applications in digital health, we are shaping the future of technology to transform the human experience.

Nokia is a registered trademark of Nokia Corporation. Other product and company names mentioned herein may be trademarks or trade names of their respective owners.

© 2022-2023 Nokia

Nokia Oyj

Karakaari 7

FI-02610 Espoo, Finland

www.nokia.com